

FRC



HIGH INTENSITY **SCENE LIGHTING** CATALOG

LED AND HALOGEN SCENE LIGHTING / LAMPHEADS / MOUNTS / ACCESSORIES AND MORE

WB[®]
WILL-BURT
Master Distributor



SUPERIOR LIGHTING



BETTER EQUIPPED TO FIGHT

Fire Research Corporation (FRC) offers cutting-edge safety solutions for fire, rescue, and emergency services. FRC has been manufacturing safety products for over 50 years. Our safety equipment, controls, instrument displays, scene lights, video and recording systems, and apparatus accessories all promote a safer working environment at the scene, on the road, or in the station.

LED SCENE LIGHTING

Radiant ECO™	6
Radiant Max™	8
Radiant Lux™ Surface Mount	10
Spectra™	12
Spectra™ Surface Mount	13
Spectra MAX™	14
Spectra MAX-S™	15
Spectra HR™	16
Spectra MS™	17
Spectra™ Slim Profile	18

RECESSED & SURFACE MOUNTS 19

Spectra™ Surface Mount	19
Spectra™ 900 Surface Mount	19
Spectra™ 950 Surface Mount	19
Evolution II™ Recess Mount	19

COST EFFECTIVE LIGHTING 20

Evolution II™	20
---------------	----

SPECIALTY LIGHTING 22

SoBrite™	22
Firefly™	24
Sunstrip™	25
Crestlight™	26
Spectra Mobile™	28
DuroLumen™	30

LIGHTING MOUNTS 31

Portable Base	31
Portable Demountable	31
LED Brow Mounts	32

TELESCOPIC POLES 34

TwistLock™ Telescopic Poles	34
Spectra/Radiant Tripod	38
TwistLock™ Tripod	39
Under Aerial	40
Fixed Top Mount	40
Fixed Side Mount	41

LIGHTING OPTIONS 42

ORDERING INSTRUCTIONS 44

DIMENSIONS 45

SPECIALTY LIGHTING 48

WorkPro™	48
----------	----

UPGRADE TO LED LIGHTING 50

THE FRC DIFFERENCE

Fire Research Corporation (FRC) was founded in 1968 and has been manufacturing innovative products designed for the Fire and Safety Industry ever since. Safety equipment, controls, instrument displays, scene lights and station accessories are shipped to truck builders, dealers, and fire departments throughout the world. Whether they are used at a scene during operations, for training, or in the station house, our products are specifically designed to promote a safer and more professional working environment.

- FRC LED lights are more efficient and use less power, provide more light and have a longer life. FRC LED's are capable of lasting well past the lifetime of the average apparatus
- FRC introduced the first LED designs/products to the market
- FRC offer more variety of scene lighting and accessory options compared to competitors
- FRC LED lampheads are designed to operate in a color temperature range that is as close to natural daylight as possible
- FRC uses an exclusive optical lens designed to control and focus the light efficiently, placing the light evenly where first responders need it
- FRC lights utilize an innovative heat sink designed to transform heat from the lamphead providing superior performance
- FRC lights are brighter, environmentally friendly, energy efficient, contain no mercury, and produce less heat
- FRC products designed, hand-built and tested in Nesconset, New York USA

FRC LIFETIME WARRANTY

FRC offers a lifetime warranty for all Radiant Series*, Spectra Series*, Evolution II, CrestLight, SoBrite, and WorkPro products installed on fire or emergency medical services apparatus. Visit the FRC website at fireresearch.com for terms and conditions.

*Excludes Model KR700 Portable, Model 600 Tripod Series, and Spectra Mobile





EXPERIENCED

FRC manufactures safety products for fire, rescue, and emergency services. At the scene, on the road, or in the station, FRC safety equipment, controls, instrument displays, scene lights, video and recording systems, and apparatus accessories all promote a safer working environment.

FRC is a leading global provider of safety solutions serving major markets including Emergency, Military, Industrial, WorkTruck, Waste, Truck/Trailer, and Bus/Rail/RV. For more information, visit <https://fireresearch.com>.

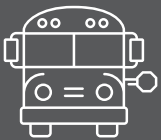

SCHOOL BUS



TRANSIT



LAW ENFORCEMENT & MILITARY



FIRE & EMS



WORK TRUCKS



TRUCK & TRAILER



WASTE & RECYCLING



CONSTRUCTION

MOST EFFICIENT OPTIC DESIGN DIRECTING ALL LIGHT FROM LEDS TO THE FIRE SCENE

SURE GRIP HANDLE

UNIQUE HIGH IMPACT LENS IS DESIGNED TO OPERATE IN A HARSH ENVIRONMENT

FLOOD AND SPOT LIGHT COMBINATION PROVIDING THE WIDEST WORK AREA COVERAGE AS WELL AS ILLUMINATING OBJECTS AT A FURTHER DISTANCE



NEW POWER SUPPLY AND LED DRIVER DESIGNED TO PROVIDE LONG OPERATING LIFE

REVOLUTIONARY HEAT SINK DESIGN KEEPING THE LED COOL AND DELIVER FULL 15,000 LUMENS OF LIGHT OUTPUT AT ALL TIME.



11 1/4" (285.7 mm)

RADIANT ECO™

15,000 LUMENS OF BRIGHT LIGHT

FEATURES



- 15,000 lumens
- No-bezel lens design
- Two lens configurations:
 - ◆ Asymmetrical lens designed for pole mounted scene lighting
 - ◆ Symmetrical lens designed for tower mount scene lighting
- Instant on at full intensity
- Available on FRC pole mount, fixed mount, and tripod
- FRC Sure Grip Handle
- Life time warranty



Standard Asymmetrical Pattern

Engineered for pole, fixed mount, top mount and tripod applications to illuminate work area while providing extreme pattern reach.

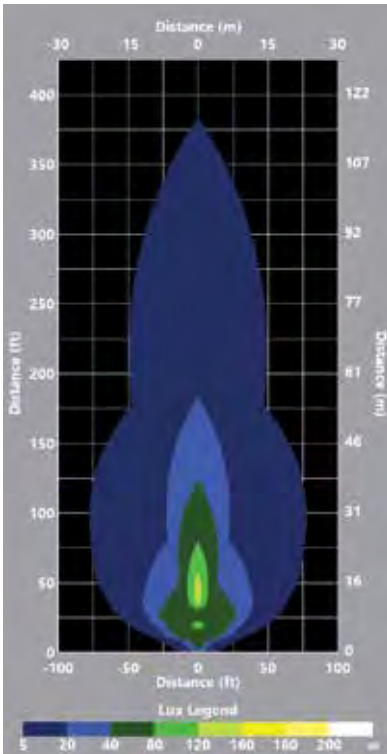

Eco Light Asymmetrical Lens
Ground Pattern Birds Eye View

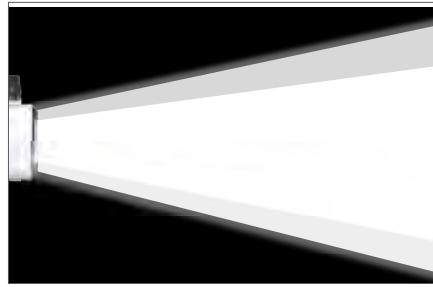

Optional Symmetrical Pattern

Light pattern designed for elevated applications, such as light towers and aerials, directs flood lighting evenly onto the work area in a cone shape while focusing a spotlight beam into the distance providing greatest coverage where it matters.

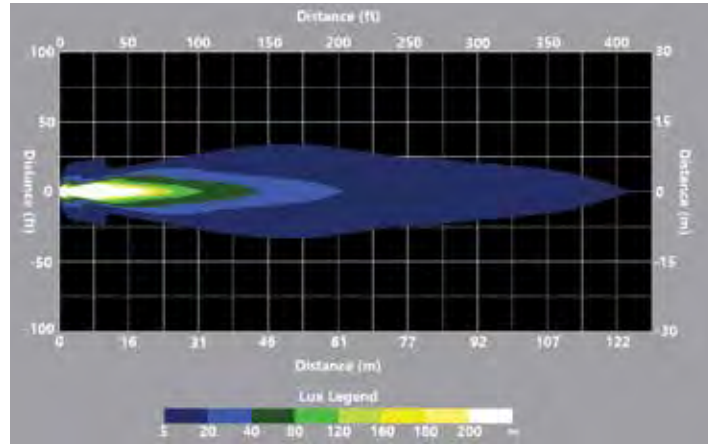

Eco Light Symmetrical Lens Cross Sectional Pattern

Specifications:

Dimensions	11.25" (285.7 mm) wide by 2.9" (73.6 mm) deep by 7" (73.6 mm) high (with handle)
Weight	AC - 7 lbs. (3.17 kg) DC - 7.5 lbs. (3.40 kg)
Lumens	15K (100W)
Voltage	12/24V DC (10A Max./5A Max.) or 120/240V AC (1.0A Max/0.5A Max.)
Power	100W
Environment Protection	IP68
Max. Operating Ambient Temperature	115° F (45°C) without any deration of light output.

					Raw lumens	Effective lumens	
			K-15	120/240 V AC	1.0A/0.5A	15,000	13,500
			Q-15	12/24 V DC	10A/5A	15,000	13,500

10 SPOT AND 78 FLOOD DIRECTING ALL THE LIGHT TO THE FIRE SCENE

UNIQUE HIGH IMPACT LENS IS DESIGNED TO OPERATE IN A HARSH ENVIRONMENT

SURE GRIP HANDLE

NEW ASYMMETRICAL OPTIC DESIGN DELIVERS THE MOST EFFECTIVE LIGHT UTILIZING SPOT & FLOOD COMBINATIONS

13.75
(412.5 mm)

NEW POWER SUPPLY AND LED DRIVER DESIGNED TO PROVIDE LONG OPERATING LIFE

REVOLUTIONARY HEAT SINK DESIGN KEEPING THE LED COOL AND DELIVER FULL 32,000 LUMENS OF LIGHT OUTPUT AT ALL TIME.

RADIANT MAX

32,000 LUMENS OF BRIGHT LIGHT

FEATURES



- New optic design utilizing a spot and flood combination to deliver light most effectively
- Mounting options include FRC poles, tripod, and fixed mounts
- Available in both 12/24V DC and 120/240V AC
- New robust arm and swivel
- Standard switch box with increased functionality:
 - ◆ On/off switch
 - ◆ Control brightness
 - ◆ Control power consumption
 - ◆ Individually control:
 - ◆ Spot only for penetrating light
 - ◆ Flood only for ground illumination
 - ◆ Flood and spot for best overall scene coverage
 - ◆ Instant on at full intensity

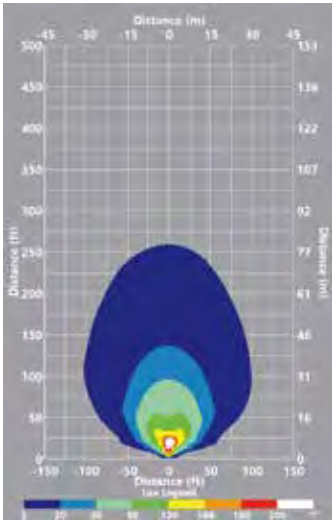

Radiant Max 100% flood 0% spot

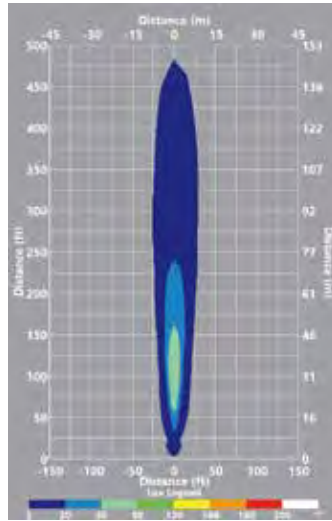

Radiant Max 0% flood 100% spot

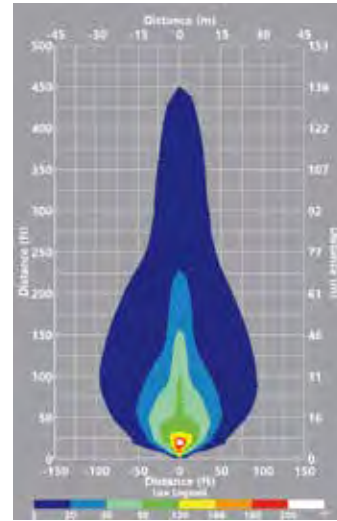

Radiant Max flood + spot mix (default mode)

MOUNTING OPTIONS



RDB600 Full tripod

RDB656 Medium tripod

RDB642 Small tripod



570 Fixed Top Mount

580 Fixed Side Mount



KR-700 Portable Base



Pole Mount

For mounting on all FRC Twistlock telescopic poles models 510, 512, 530, 540 and 542

Specifications:

Dimensions	13.75" (349.25 mm) wide x 3.75 (95.25 mm) deep x 7.5 (190.5 mm) high
Weight	AC - with arm & swivel 8.9 lbs (4 kg) DC - with arm & swivel 7.9 lbs (3.6 kg)
Lumens	32,000 Lumens
Color Temperature	6500 Kelvin (Daylight)
Voltage	120/240VAC and 12/24VDC
LED Distribution	10 Spot and 78 Flood
Power	220W
Environment Protection	IP68
Max. Operating Ambient Temperature	115° F (45° C) without any deration of light output.

					<u>Raw lumens</u>	<u>Effective lumens</u>
		K-32	120/240 V AC	1.7A/0.9A	32,000	28,000
		Q-22	12/24 V DC	18A/9A	32,000	28,000



10 SPOT LEDS AND 56 FLOOD LEDS



SLEEK NEW DESIGN IS AVAILABLE WITH BLACK, CHROME OR WHITE BEZELS

NEW ASYMMETRICAL OPTIC DESIGN DELIVERS THE MOST EFFECTIVE LIGHT TO THE IMMEDIATE WORK AREA AND EXTENDED SCENE REACH

REVOLUTIONARY HEAT SINK DESIGN KEEPING THE LED COOL AND DELIVER FULL 22,000 LUMENS OF LIGHT OUTPUT AT ALL TIME



RADIANT LUX

SURFACE MOUNT
22,000 LUMENS OF
BRIGHT LIGHT

FEATURES



- Sleek rugged design available with a black, chrome, or white bezel
- Standard switch control or an optional CANbus for increased functionality
- CANbus control:
 - ◆ Dimable to tune brightness or control power consumption
 - ◆ Spot and flood sections can be controlled individually
 - ◆ Isolate light sections and control for specific applications:
 - ◆ Spot only for penetrating light
 - ◆ Flood only for ground lighting
 - ◆ Both for maximum illumination
 - ◆ Functions mix and match

The Radiant Lux is the brightest surface mount light on the market!

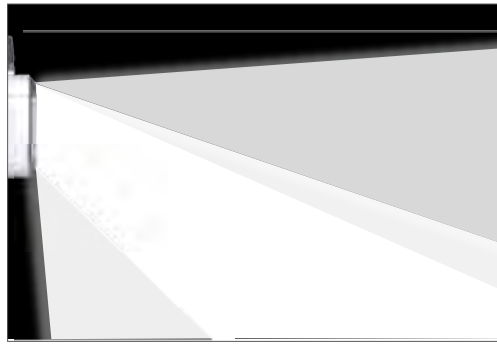
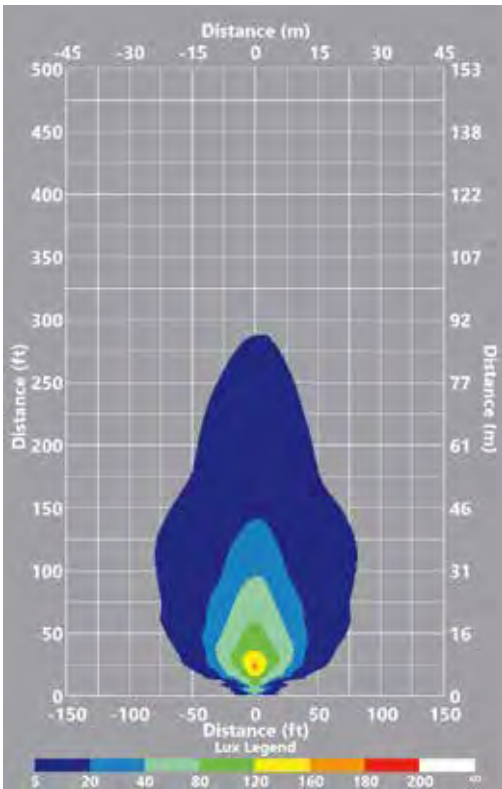

FRC's Innovative Asymmetrical Pattern
Engineered to illuminate work area while providing extreme pattern reach.



Specifications:

Dimensions	AC - 16.24 (412.5 mm) wide x 3.7 (93.98 mm) deep x 6.375 (161.93) high (with surface cut out) DC - 16.24 (412.5 mm) wide x 2.2 (55.8 mm) deep x 6.375 (161.93 mm) high (no surface cut out)
Weight	AC - 7.5 lbs. (3.4 kg) DC - 7.0 lbs (3.1 kg)
Lumens	22,000 Lumens
Color Temperature	6500 Kelvin (Daylight)
LED Distribution	10 Spot LEDs and 56 Flood LEDs Optional 28 Amber LEDs - Flash or directionally control lights for warning alerts
Voltage	12/24V DC (10A Max./5A Max.) or 120/240V AC (1.0A Max/0.5A Max.)
Power	150W
Environment Protection	IP68
Max. Operating Ambient Temperature	115° F (45°C) without any deration of light output.
Controller	Available with or without CANbus

					<u>Raw lumens</u>	<u>Effective lumens</u>
	K-22	120/240 V AC	1.0A/0.5A		22,000	19,800
	Q-22	12/24 V DC	10A/5A		22,000	19,800

"SURE GRIP" HANDLE STAYS COOL TO THE TOUCH WHEN HOLDING LAMPHEAD

FLOOD LED (TOP & BOTTOM ROWS) ILLUMINATE THE WORK AREA

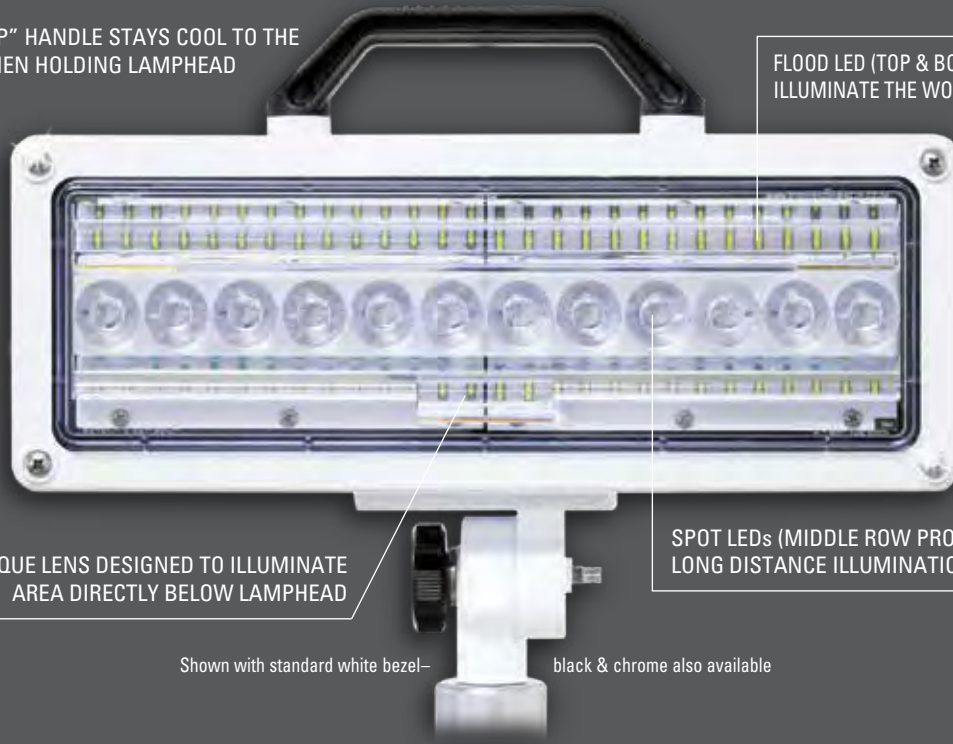

UNIQUE LENS DESIGNED TO ILLUMINATE AREA DIRECTLY BELOW LAMPHEAD

SPOT LEDs (MIDDLE ROW PROVIDE LONG DISTANCE ILLUMINATION

Shown with standard white bezel-

black & chrome also available

SPECTRA™

20,000 LUMENS OF BRIGHT LIGHT

SPECTRA FEATURES



- Slimmest LED profile in the industry
- Unique combination of flood/spot LEDs
- Instant-on at full intensity
- Longer LED life rated at 50,000 hours

- Available in 15,000 or 20,000 lumens
- Innovative cooling fins provide higher efficiency
- Available on FRC pole, brow, fixed or surface mounts

PUTS ALL LIGHT DIRECTLY ON THE WORK AREA & SCENE BEYOND



Three rows of LEDs - Top and bottom rows are flood LEDs designed to light up the work area. The middle row of focused spot LEDs provide long distance illumination.

SPECTRA's unique lens design provides a smooth and uniform flood and spot combination bringing firefighters the widest light pattern for improved work area visibility as well as illuminating objects at a farther distance.

SPECTRA's advanced lens design and arrangement of powerful LEDs deliver bright LED light where its needed.



SPECTRA LED lampheads output an impressive 20,000 lumens of super bright LED light. The advanced lens and arrangement of LEDs generate a unique combination flood and spot light pattern.

					Raw lumens	Effective lumens
	Q20	12/24 V	18.3/9.2A		20,000	18,000
	K20	120 V	1.8A		20,000	18,000
	J20	240 V	0.9A		20,000	18,000

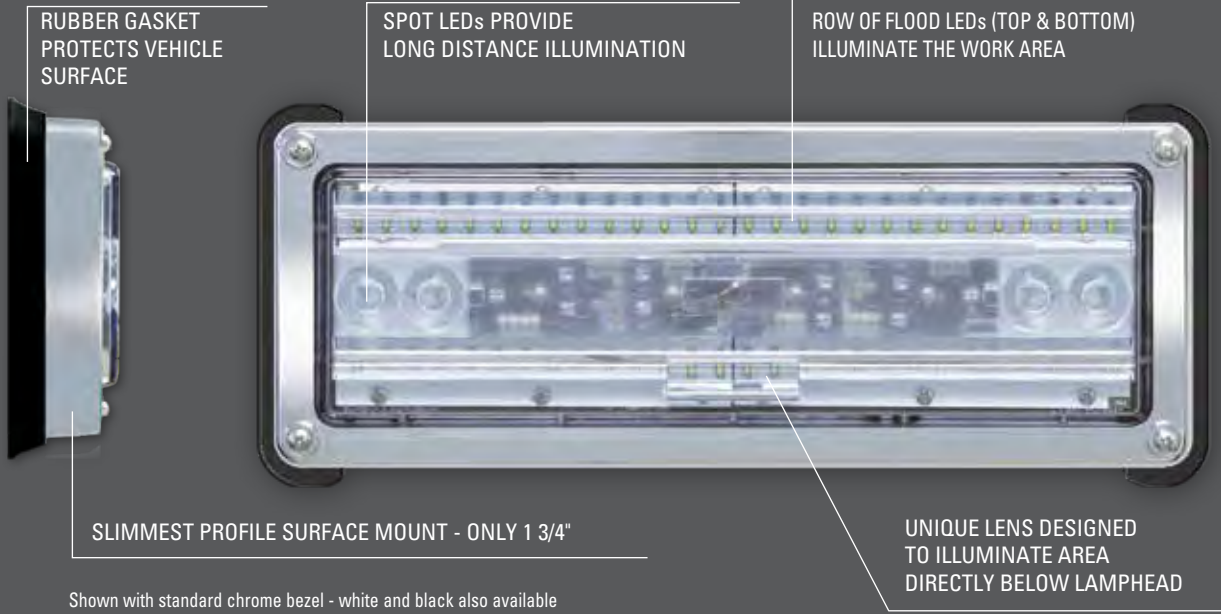

Shown with standard chrome bezel - white and black also available

SPECTRATM SURFACE MOUNT

15,000 LUMENS OF BRIGHT LIGHT

SPECTRA SURFACE MOUNT FEATURES



- Surface mount LED lamphead generates a combined flood and spot light pattern
 - Slim body design depth of only 1 3/4" keeps lamphead closer to vehicle
 - Surface mount is easier and faster to install
 - Available in 12/24 VDC or 120/240 VAC
- AC surface mount model SPA260 requires 6 3/8" w x 4 11/16" h cut-out

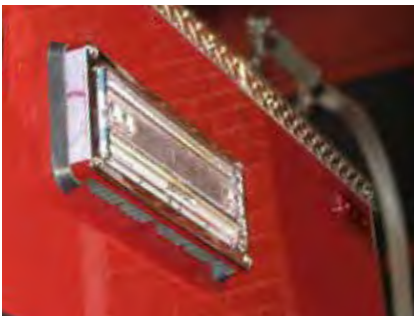

SPECTRA SURFACE MOUNT



has an extremely low profile extending less than 1-3/4" from the panel.

					Raw lumens	Effective lumens
	Q15	12/24 V	13.9/6.9A		15,000	13,500
	K15*	120 V	1.4A		15,000	13,500
	J15*	240 V	0.7A		15,000	13,500

* Surface mount SPECTRA models only

"SURE GRIP" HANDLE STAYS COOL TO THE TOUCH WHEN HOLDING LAMPHEAD

2 ROWS OF INTENSE FLOOD LEDs PROVIDE THE ULTIMATE IN SCENE & WORK AREA ILLUMINATION

CENTER ROW OF BRIGHT SPOT LEDs OFFER LONG DISTANCE ILLUMINATION

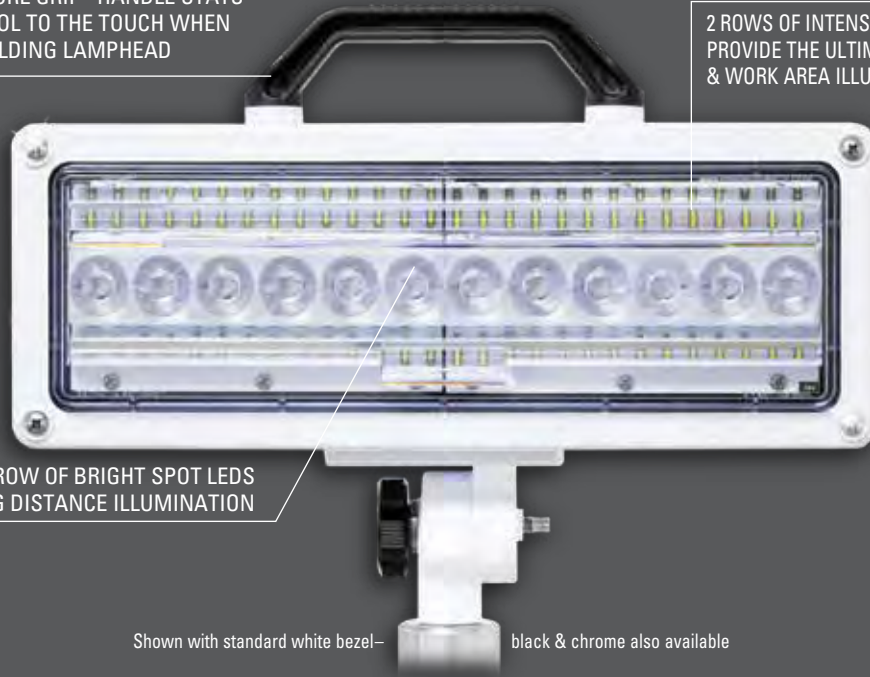

Shown with standard white bezel— black & chrome also available

THE BRIGHTEST LED SCENE LIGHT AVAILABLE

SPECTRA MAX™

FEATURES



- Available in 12/24 VDC or 120/240 VAC
- Choose pole, brow, fixed or surface mounts
- 28,000 lumens of bright light

THE BRIGHTEST SURFACE MOUNTED LED LAMPHEAD AVAILABLE

SPECTRA-MAX SURFACE MOUNT

- 20,000 lumens of ultra bright light to improve vehicle performance



SPECTRA MAX lampheads deliver 28,000 lumens of ultra bright LED light in a uniform light pattern providing maximum scene and work area visibility.

					Raw lumens	Effective lumens
IP68	CE	Q20*	12/24 V	13.8/6.9A	20,000	—
		Q28	12/24 V	19.2/9.6A	28,000	25,200
UL IP68	CE	K20*	120 V	1.4A	20,000	—
		K28	120 V	1.8A	28,000	25,000
UL IP68	CE	J20*	240 V	0.7A	20,000	—
		J28	240 V	1.4A	20,000	—

* Surface mount SPECTRA models only

"SURE GRIP" HANDLE STAYS COOL TO THE TOUCH WHEN HOLDING LAMPHEAD

3 ROWS OF POWERFUL SPOT LEDs ILLUMINATE OBJECTS FARTHER AWAY



BOTTOM ROW OF INTENSE FLOOD LEDs ILLUMINATE ENTIRE SCENE & WORK AREA

Shown with standard white bezel— black & chrome also available

MAXIMUM SPOT AND FLOOD LIGHT CAPABILITY

SPECTRA MAX-S™

FEATURES



- SPECTRA MAX-S combines a flood light with an intense long-distance spotlight to let you see objects farther away
- Select Spot (14,000 lumens) or Flood (14,000 lumens) Light Patterns or 28,000 lumens Spot/Flood Combination
- Available in 12/24 VDC or 120/240 VAC
- Choose Pole, Brow, or Fixed Mounts

SPECTRA MAX SERIES LAMPHEADS DELIVER MAXIMUM SCENE AND WORK AREA VISIBILITY



SPECTRA MAX lampheads deliver 28,000 lumens of ultra bright LED light in a uniform light pattern providing maximum scene and work area visibility.

					<u>Raw lumens</u>	<u>Effective lumens</u>	
IP68	CE	■	A28	12/24 V	20.8/10.4A	28,000	25,200
IP68	CE	■	B28	120 V	2.8A	28,000	25,200
IP68	CE	■	C28	240 V	1.4A	28,000	25,200



ENGINEERED TO ILLUMINATE TALL BUILDINGS

SPECTRA HR™

FEATURES



- Two distinct groups of lenses are utilized:
 - Upper Group - designed so each lens projects wide beams of light at different angles to cover the entire vertical face of the building
 - Lower Group - designed to illuminate the ground ahead of the apparatus
- Each group can be turned on or off individually
- 72 ultra-bright white LEDs - 34 for the Upper Group and 38 for the Lower Group
- Adjustable, pivoting mounting arm incorporates a round, sturdy, reinforced knurled locking knob
- Sure-Grip molded handle ensures reliable grip every time and keeps the handle cool to the touch
- Lamp head measures 14" (355 mm) W x 3 3/4" (95 mm) D x 5 3/8" (137 mm) H
- Available in both 12/24 VDC and 120/240 VDC, with or without a switch
- Choose from the standard white bezel or the optional chrome or black bezels
- Choice of Pole or Tripod mount with or without a switch
- UL certification

The Spectra HR uses two unique groups of lenses. The upper group projects wide beams at different angles to cover the entire vertical face of the building. At the same time the lamphead's lower group lights the ground area in front of a fire apparatus. Each 28,000 lumen Spectra HR achieves this illumination without lamp adjustment.

				<u>Raw lumens</u>	<u>Effective lumens</u>
	J28	240 V	1.4A	28,000	23,800
	K28	120 V	2.8A	28,000	23,800
	Q28	12/24 V	19.2/9.6A	28,000	23,800

SURE-GRIP
MOLDED HANDLE



POWERFUL SPOT/FLOOD
LEDs DELIVER MORE LIGHT
ECONOMICALLY & EFFICIENTLY

COMPACT LAMPHEAD DESIGN -
ONLY 8 3/4" WIDE BY 3 1/4" DEEP

THICKER, REINFORCED
MOUNTING KNUCKLE

Shown with optional chrome bezel— white standard & black also available

SLIM, COMPACT AND POWERFUL SPECTRA MS™

FEATURES



- SPECTRA MS combines spot and flood LEDs for a uniform light pattern
- Compact and Powerful - Measures just 8 3/4" wide by 3 1/4" deep
- Efficient - More LED light using less power
- Economical LED solution for upgrading your vehicle
- Available in 12/24 VDC or 120/240 VAC
- Choose Pole, Brow, or Fixed mounts
- 14,000 lumens of bright light

SPECTRA MS LED lampheads are slim, compact, and provide an efficient 14,000 lumens of bright LED light.

					Raw lumens	Effective lumens
IP68	CE	■	R14	12/24 V 10.8/5.4A	14,000	12,600
UL	CE	■	T14	120 V 1.4A	14,000	12,600
IP68						
UL	CE	■	U14	240 V 0.7A	14,000	12,600
IP68						

SPECTRA 950 PERIMETER ILLUMINATION



SLIM PROFILE SURFACE MOUNT LESS THAN 2" • COMPACT SIZE 9" x 6 3/4"
SPECTRA 950 / 900 Shown with standard chrome bezel – black & white also available

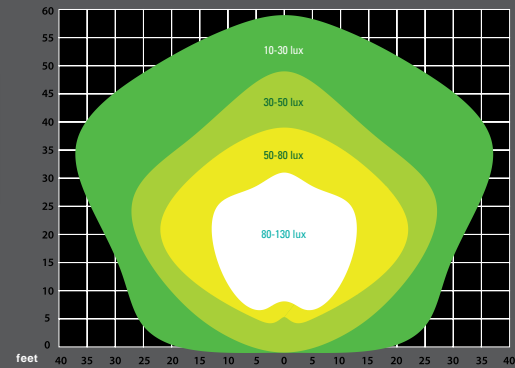

Unique SPA950 pattern at 8' height aimed horizontal (0° inclination)

DESIGNED FOR AMBULANCE AND EMERGENCY RESPONSE VEHICLES

SPECTRA™ SLIM PROFILE

FEATURES



- 5,000 lumens of light projects 170° illuminating underneath and across to light up the body of vehicle and immediate work area
- Complex single lens optic design engineered for unmatched performance
- Easy installation, no panel cut-out. Rubber gasket protects vehicle surface
- Operating hours: 50,000+

SPECTRA 900 SCENE ILLUMINATION



- Ultra-Bright 7,000 lumen LED scene lighting using 24 white LEDs
- Innovative lens redirects the light along the vehicle and directly onto the scene
- Easy installation, no panel cut-out
- Heat sink design offers greater light output
- Rubber gasket protects vehicle surface

SLIM PROFILE SURFACE MOUNT LESS THAN 2" • COMPACT SIZE 9" x 6 3/4"

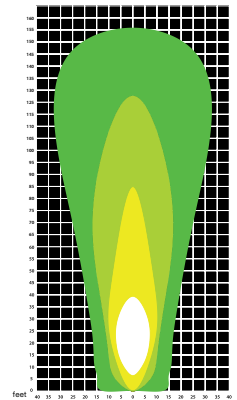

Unique SPA900 pattern at 8' height aimed horizontal (0° inclination)

SPECTRA 900 LED was designed specifically to focus all light directly on the scene.

SPECTRA 950 LED casts light underneath and across to illuminate vehicle and work area.

Both lights are easy to install with NO PANEL CUT OUT required.

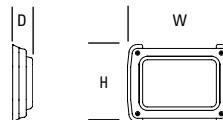

SPA900, SPA950

Model	W	D	H
Q70	9	1 3/4	6 3/4



SPECTRA 900 SCENE ILLUMINATION

Q70 12/24 V 6.0/3A

SPECTRA 950 PERIMETER ILLUMINATION

T14 12/24 V 5.0/2.5A

	Raw lumens	Effective lumens
SPECTRA 900 SCENE ILLUMINATION (Q70)	7,000	5,950
SPECTRA 950 PERIMETER ILLUMINATION (T14)	5,000	4,500



SPECTRA

Lowest Profile LED Surface Mount Models SPA260 • SPA900 • SPA950

- LEDs generate a unique combined flood & spot light pattern
- Available in 15,000 lumens Spectra and 20,000 lumens Spectra Max
- Available in 12/24 VDC or 120/240 VAC
- AC surface mount model SPA260 requires a 6 3/8" w x 4 11/16" h cut-out

SURFACE MOUNTS AVAILABLE FOR SPECTRA Q15, K15, J15 & SPECTRA MAX Q20, K20, & J20



SPECTRA 900

Slim Profile LED Surface Mounts

- Ideal scene light for ambulance and emergency response vehicles
- Ultra-bright 7,000 lumens of light

Easy installation, requires no panel cutout. Slim profile less than 2" deep

SURFACE MOUNTS AVAILABLE FOR SPECTRA 900 Q70



SPECTRA 950

Slim Profile LED Surface Mounts

- Ideal perimeter light for ambulance and emergency response vehicles
- Ultra-Bright 5,000 lumens of light

Easy installation, requires no panel cutout. Slim profile less than 2" deep

SURFACE MOUNTS AVAILABLE FOR SPECTRA 950 Q50



EVOLUTION II

Generates 15,000 lumens of Bright Light Model FCA210

Recess requires only 2" of depth

SURFACE MOUNTS AVAILABLE FOR SPECTRA Q15, K15, J15 & SPECTRA MAX Q20, K20, & J20



FEATURES



- Brighter Light - More than 20,000 lumens of ultra bright led light
- Whiter Light – Closest thing to natural sunlight
- Uniform high quality white light with the widest light pattern
- Long Operating Hours – Rated at 50,000 hours
- Parabolic reflector and lens designed to direct all the light onto the scene
- Lamphead can be used with 12 or 24 volt DC systems (13/6.5 amps)
- Full Brightness at Power On – Instant restarts

EVOLUTION II low profile LED lampheads generate up to 20,000 lumens of ultra bright white light. The unique LED arrays and lens produce more usable light in a compact lamphead.



V11	12/24 V	7.5/3.75A	11,000	lumens
V15*	12/24 V	11.0/5.5A	15,000	lumens
V20	12/24 V	13.0/6.5A	20,000	lumens

*Recessed Evolution II model only

Advanced Lens Design **See All the Action Further Away!**



The EVOLUTION II lens focuses more LED light on the scene and objects far away.





Shown with standard yoke mount (model SRA100)

SOBRITE™ COMPACT, ULTRABRIGHT LED LIGHT



MOUNTS ALMOST ANYWHERE

SoBrite LED easily retrofits to existing Collins Dynamics® FX and Unity AG-L mounting bases.

Shown with fixed mount (model SRA110) and optional black housing



FEATURES



- 7,000 lumens of intense LED light
- Built tough for long life in the harshest environments
- Versatile design offers multiple mounting options
- Ideal LED upgrade for your existing vehicles
- 12/24 VDC - 5/2.5 Amps

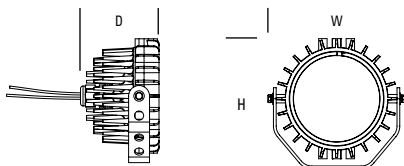

SRA100

Model	W	D	H
07A	6 1/4	3 3/4	5 15/16

THREE MODELS, THREE LIGHT PATTERNS

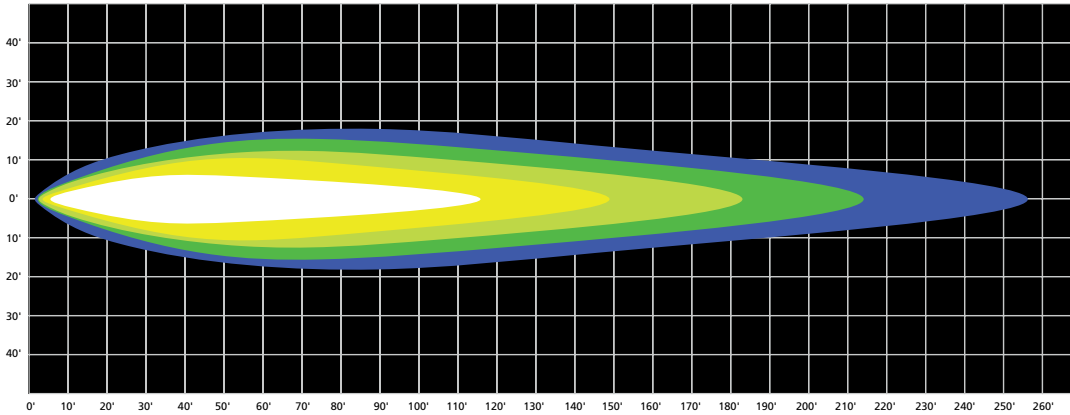

MODEL SRA100-07A

SPOT PATTERN:

A focused and concentrated long range light beam for illuminating objects in the distance.

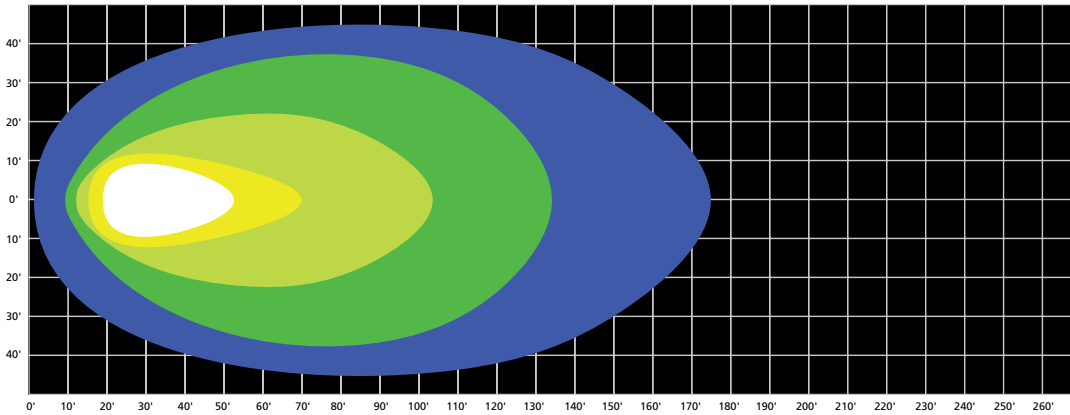

MODEL SRA100-07B

FLOOD PATTERN:

Widest pattern of light that is perfect for evenly illuminating the work area.

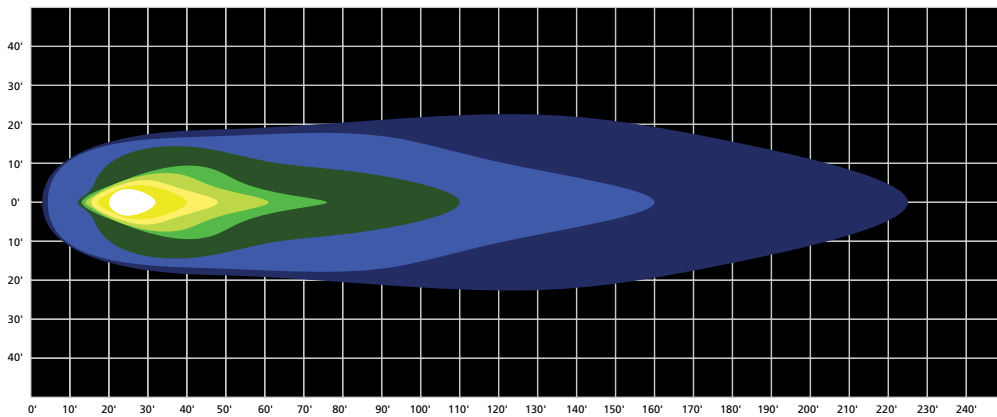

MODEL SRA100-07C

TRAPEZOID PATTERN:

Wider than a spot and longer than a flood, this light pattern is ideal as a general-purpose work light. Ideal for mounting on front of vehicle for increased visibility while driving.

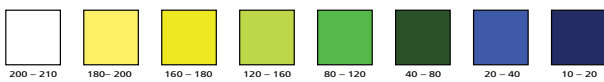



FIREFLY™ MOST COMPACT ULTRABRIGHT WHITE LED LIGHT FOR COMPARTMENTS, PANELS & UNDER BODY APPLICATIONS

FEATURES

- Small and Compact - Four (4) white, long life LEDs
- UltraBright 650 lumens light output
- Mounts in any orientation & on any flat surface
- 12 VDC-0.8 Amps / 24 VDC-0.4 Amps
- Low power consumption saves energy
- Instant on at full intensity
- Can be used in compartments, on panels, and for ground or surface lighting
- The LEDs are housed in a waterproof anodized aluminum case, built tough for all environments

LED 110 FLOOD BEAM for wider illumination
LED110 - Q01 WORK LIGHT PERFECT FOR UNDER VEHICLE

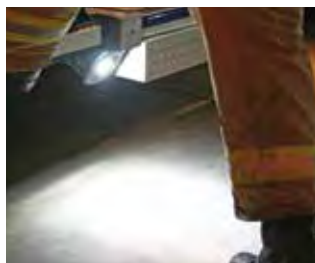

LED 100 DIRECTED BEAM for focused light
LED100 - Q01 COMPARTMENT LIGHT WITH GLARE REDUCING LENS

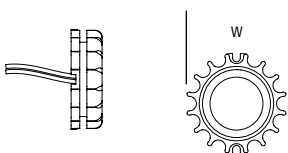

LED100, LED110

Model	W	D
Q01	2 5/8	3/4

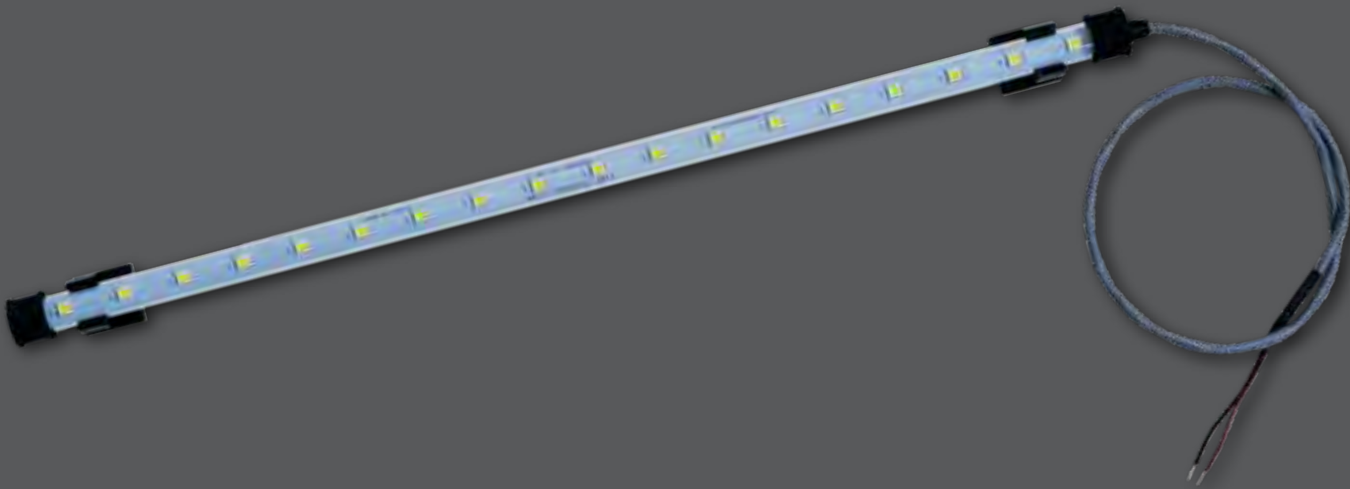

SUNSTRIP™ ULTRABRIGHT WHITE LED LIGHT FOR COMPARTMENTS, PANELS, UNDER BODY APPLICATIONS, WALKWAYS & STAIRWAYS

FEATURES

- UltraBright strip light – More than 300 lumens of LED Light per 18" length
- LEDs housed in a strong 5/8" diameter lexan tube
- Designed tough to withstand any vehicle vibration
- Waterproof and submersible
- Great for all applications
- Easy to install
- Long operating hours – Rated at 50,000 hours
- Available in 9" length increments from 9" to 63"

Part No.	Lumens	Current @ 12V
LED200 - A09	150	0.17 amps
LED200 - A18	300	0.35 amps
LED200 - A27	450	0.52 amps
LED200 - A36	600	0.70 amps
LED200 - A45	750	0.87 amps
LED200 - A54	900	1.05 amps
LED200 - A63	1050	1.22 amps

*Add 2" for end caps & wire clearance
Mounting clips supplied • 24V also available

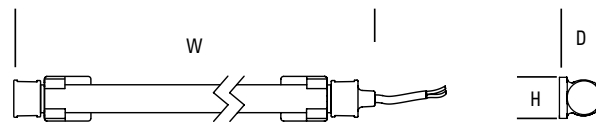

LED200, LED201

Model	W	D	H
A09	10 1/8	1 1/16	1
A18	19 1/8	1 1/16	1
A27	28 1/8	1 1/16	1
A36	37 1/8	1 1/16	1
A45	46 1/8	1 1/16	1
A54	55 1/8	1 1/16	1
A63	64 1/8	1 1/16	1





CRESTLIGHT™ THE BEST BROW LIGHT FOR THE JOB

FEATURES



- Lowest profile scene light in the industry at just under 2"
- Only brow lighting in the industry with individual low beam optic LED's
- Built in DOT marker light
- Available in white or black powder coated housing
- Independent control for the marker, flood and low beam LEDs
- Ideal for working vehicle scenes
- Will not blind passing traffic or emergency personnel on the opposite side of the scene

CHOOSE THE MODEL THAT'S BEST FOR YOU

CLA100 - white narrow flood, white low beam, amber DOT marker or CLA101 without DOT markers

CLA101 - A68	71.6" long	CLA101 - Same as above without Amber DOT	17,800 lumens
CLA100 - A62	65.2" long	White narrow flood, white low beam, amber DOT marker	16,100 lumens
CLA101 - A62	65.2" long	CLA101 - Same as above without Amber DOT	16,100 lumens
CLA100 - A49	42.5" long	White narrow flood, white low beam, amber DOT marker	12,500 lumens
CLA101 - A49	42.5" long	CLA101 - Same as above without Amber DOT	12,500 lumens
CLA100 - A14	17.5" long	White low beam	2,600 lumens
CLA101 - A28	30.25" long	White narrow flood	5600 lumens
CLA200 - A14	17.5" long	Amber low beam	2600 lumens

EXCLUSIVE LOW-BEAM LENS DIRECTS FLOOD LIGHT OUT AND DOWNWARD.

Low beam light projection on a typical 8' (2.5 m) high apparatus will provide forward coverage up to 150' (45 m) and side coverage to 60' (18 m) wide.

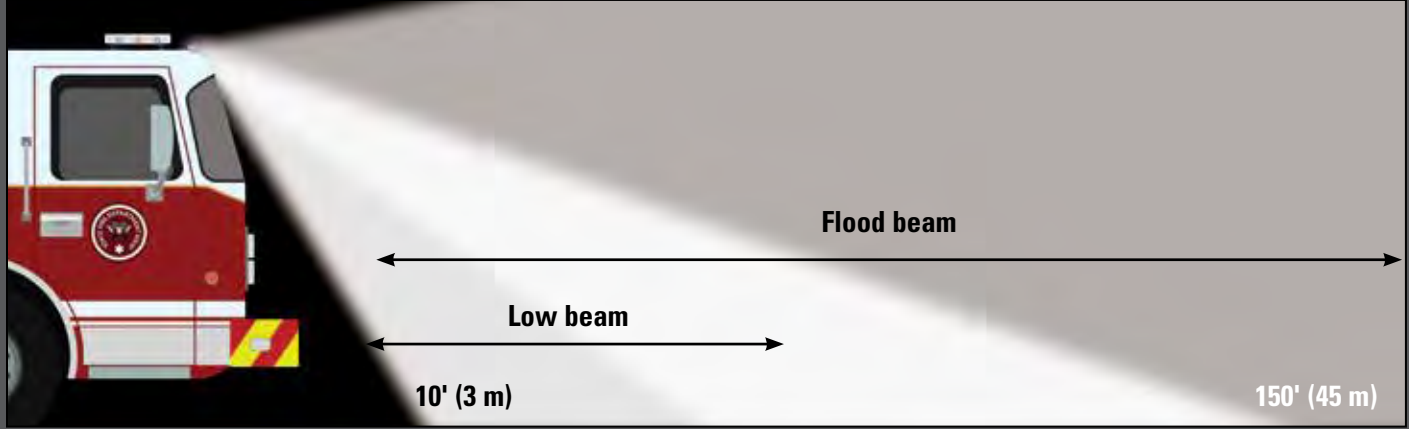

CrestLight low profile LED scene lights provide the flexibility to offer the proper light for the job. The CrestLight is a combination of three different lights, white narrow flood, white low beam, and amber DOT markers.

12V•24V	Model	Voltage	Current	Lumens
■	A14	12/24 V	4.2/2.1A	2,600 lumens
■	A49	12/24 V	13.7/6.8A	12,500 lumens
■	A62	12/24 V	17.5/8.7A	16,100 lumens
■	A68	12/24 V	19.5/9.7A	17,800 lumens
■	A28	12/24 V		5,600 lumens

Model		A	B	C	D	E
		Width w/ Bracket	Mounting Holes	Height w/ Bracket	Height w/o Bracket	Depth
CLA101-A49	inch	52 1/2	51 5/8	3	1 13/16	3 5/16
	mm	1308.1	1311.3	76.2	46.1	84.1
CLA101-A62	inch	65 1/4	64 3/8	3	1 13/16	3 5/16
	mm	1657.4	1635.1	76.2	46.1	84.1
CLA101-A68	inch	71 5/8	70 3/4	3	1 13/16	3 5/16
	mm	1819.4	1797.1	76.2	46.1	84.1
CLA101-A28	inch	30 1/4	29 5/16	3	1 13/16	3 5/16
	mm	768.4	744.5	76.2	46.1	84.1

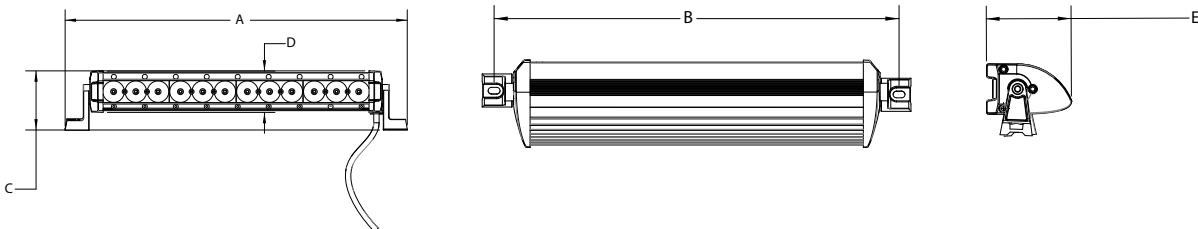



DESIGNED FOR AMBULANCE AND EMERGENCY RESPONSE VEHICLES
SPECTRA MOBILE™

FEATURES

- 15,000 lumens Spectra lamphead
- Compact lamphead design
- Plunging and hanging spike
- Rubber hanging strap
- Pole mountable (optional)
- 5-light operating modes
- Compatible with Milwaukee® battery, 18v, 12Ah
- Low battery alerts with a “Double Flash” when the voltage starts to reach a low level. Light will automatically turn off when the battery level is low. 12Ah rechargeable battery is compatible with other battery operated tools you may already own

- Rubber strap for hanging the light
- Compact lamp head design only 8¾" (222 mm) wide by 3¾" (95 mm) deep
- Lexan® lens
- Aluminum pole mount receiver (optional)
- ABS molded handle
- 5 position switch
- Retractable spike can be used as a hook to secure the light
- 12Ah rechargeable battery
- Stainless steel legs

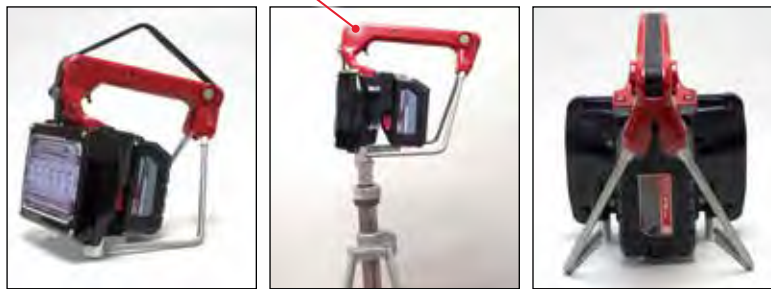

OPERATING MODES

- On-Flood
- 1st toggle-spot
- 2nd toggle-warm/medium
- 3rd toggle-amber
- 4th toggle-flashing amber
- Down-off
- Hold the switch in any of the operating modes to switch from Full - Medium - Low

12 Ah Battery Specifications:

	Full	Mid	Low
Flood	1:40 15000 lumens	4:20 5500 lumens	12:00 2000 lumens
Spot	4:30 5000 lumens	9:00 2500 lumens	21:30 1000 lumens
Warm	2:10 9800 lumens	4:20 5400 lumens	12:00 1800 lumens
Amber	2:40 6000 lumens	5:20 3500 lumens	21:30 1000 lumens

Times are listed in Hours:Minutes

Specifications:

Dimensions	8¾" (222 mm) wide by 3¾" (95 mm) deep
Weight	11 lbs. (5 kg) (with battery)
Materials	Lexan lens ABS molded handle Stainless steel legs, kick stand, spike Aluminum pole mount receiver

Model Numbers:

SPA710-P15	Spectra Mobile LED 15,000 lumens scene light, with battery and charger
SPA710option-NB	Spectra Mobile LED 15,000 lumens scene light only (battery and charger not included)



HIGH PERFORMANCE LED INTERIOR LIGHTING DUROLUMEN™

FEATURES

- Reverse polarity and over/under voltage protected
- Easy retrofit – fits Grote and TruckLite hole patterns: 3.5" x 16" x 1"
- Recessed housing – Nearly flush mount pan fits tight along walls and ceilings

Part No.	Description	Voltage	Amps	Lumens
R03696	Surface mount. White/White offers high or low beam intensity switching (user supplied switch)	9–16 VDC	2.5 high 1.25 low	2,800 high 1,400 low
R03694	Surface mount. White only	9–16 VDC	1.25 low	1,400
R03695	Recessed mount. Red/White offers high or low beam intensity switching (user supplied switch)	9–16 VDC	1.25 low	1,400 white 500 red
R03850	Recessed mount. White/White offers high or low beam intensity switching (user supplied switch)	9–16 VDC	2.5 high 1.25 low	2,800 high 1,400 low
R03848	Surface mount. White only	9–16 VDC	1.25 low	1,400
R03849	Recessed mount. Red/White offers high or low beam intensity switching (user supplied switch)	9–16 VDC	1.25 low	1,400 white 500 red

PORTABLE BASE

MODEL KR-700

- Grab-and-run versatility
- Cast aluminum portable base
- Available with any AC light fixtures
- LED lampheads provide more light per watt than traditional quartz halogen fixtures



-HD Hold Down Assembly

Lamphead with portable base easily stores in most vehicle compartments or storage areas

Wire guard comes standard for Focus lampheads



PORTABLE DEMOUNTABLE

DM OPTION

- Combines the benefits of a telescoping pole and a 700 Series portable light
- Hold-down assembly fastens light to permanently-mounted baseplate (-HD)
- Mounted on any of the telescoping poles
- On/Off switch standard
- Add suffix -DM to complete pole mount
- Also available without pole



LED BROW MOUNTS

HIGHLY EFFICIENT LEDS PROVIDE FIVE-TIMES MORE LIGHT THAN HALOGEN BULBS



MODEL FCA800

TURN NIGHT INTO DAY

Arrive at a nighttime scene and power-up your new SPECTRA or EVOLUTION II brow mounted LED lampheads for the brightest light. Perfect for new and existing vehicles.

BROW LIGHTS ARE AVAILABLE WITH THE FOLLOWING LAMPHEADS:

- SPECTRA: Q15, Q20, J20, K20
- EVOLUTION II: V11, V20
- SPECTRA MAX: Q28, J28, K28
- SPECTRA MAX-S: A28, B28, C28
- FOCUS: D15, D30, H30, S30, S50, S75, M10, M12, M15
- SPECTRA MS: R14, T14, U14



MODEL SPA850
FLAT MOUNT

CONTOUR, UNIVERSAL & FLAT MOUNTING

PERFECT FOR MOUNTING ON ROOF OF CAB

BROW LIGHTING FEATURES

- UltraBright Illumination
- Light up the scene quickly upon arrival
- Very low profile
- Available for SPECTRA SERIES and EVOLUTION II

UNIVERSAL MOUNT

DESIGNED TO MOUNT ON ANY CAB

- Universal mounting bracket easily installs on all apparatus



MODEL SPA830

CONTOUR BROW MOUNT



MODEL SPA800

TWISTLOCK TELESCOPIC POLES



MODEL 510
Top Mount, Pull Up Telescopic Pole

- 3.25" round mounting flange is standard
- 2.5" square flange is available other 510C and 510E (see insets)

OPTIONS:

- CL (custom length pole)
- SW (raised pole switch and indicator)
- TW (wire out of the top of the pole)



MODEL 510C
 Model 510 pole with a Square Flange Option



MODEL 510E
 Model 510 pole with a Square Flange Option for mounting in a 3" extrusion

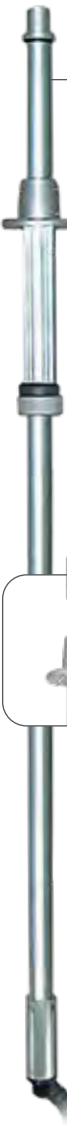

MODEL 512
Thru The Roof, Push Up Telescopic Pole

- Extension pole has a knurled aluminum push-up handle
- A round, "no drip" mounting flange is provided



No-Drip Thru the Roof, Push up Pole

OPTIONS:

- CL custom length pole)
- SW (raised pole switch and indicator)
- TW (wire out of the top of the pole)
- SR (steady rest bottom bracket)



MODEL 530
Side Mount, Push Up Telescopic Pole

- Extension pole has a knurled aluminum push-up handle
- Outer tube is grooved aluminum extrusion and qualifies as a NFPA compliant handrail
- Standard outer tube (shown) is 20". Choosing an optional 10" outer tube allows for a 40" extension

OPTIONS:

- CL (custom length pole)
- SW (raised pole switch and indicator)
- TW (wire out of the top of the pole)
- SR (steady rest bottom bracket)
- ST (10" outer tube)

FEATURES

- All FRC telescopic poles are made of anodized aluminum for maintenance free performance and longer service life.
- All extension poles rotate 360°
- All extension poles have the exclusive TwistLock mechanism to secure the pole in position.
- All standard extension poles have a four foot retractable cord extending from the bottom for direct wiring.
- All outer tubes have a grooved surface
- All pole mounted lampheads have a pivot in the mounting arm with a knurled knob to adjust the angle of elevation.

PATENTED SAFETY TWISTLOCK

- Easy to use and can be operated in either direction.
- It can not jam or be over tightened.
- There is no protruding handle to snag gear or straps on.
- Knurled surface for a firm grip.
- The locking mechanism has no metal to metal contact. This spares the anodized aluminum poles from unnecessary wear and tear.



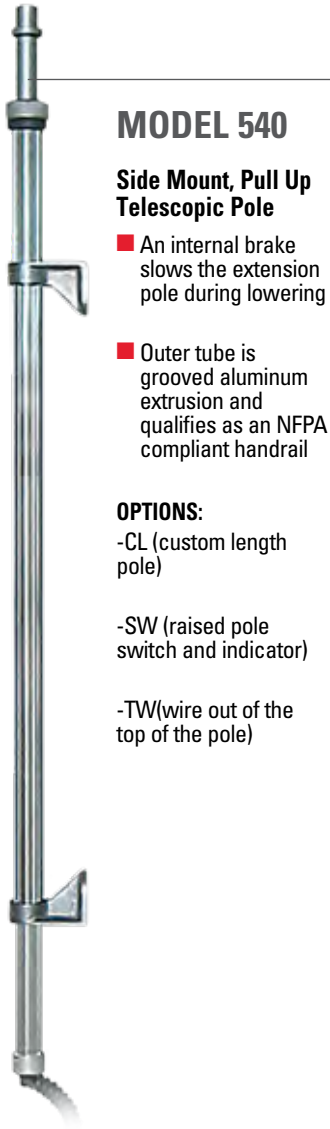

MODEL 540

Side Mount, Pull Up Telescopic Pole

- An internal brake slows the extension pole during lowering
- Outer tube is grooved aluminum extrusion and qualifies as an NFPA compliant handrail

OPTIONS:

- CL (custom length pole)
- SW (raised pole switch and indicator)
- TW (wire out of the top of the pole)

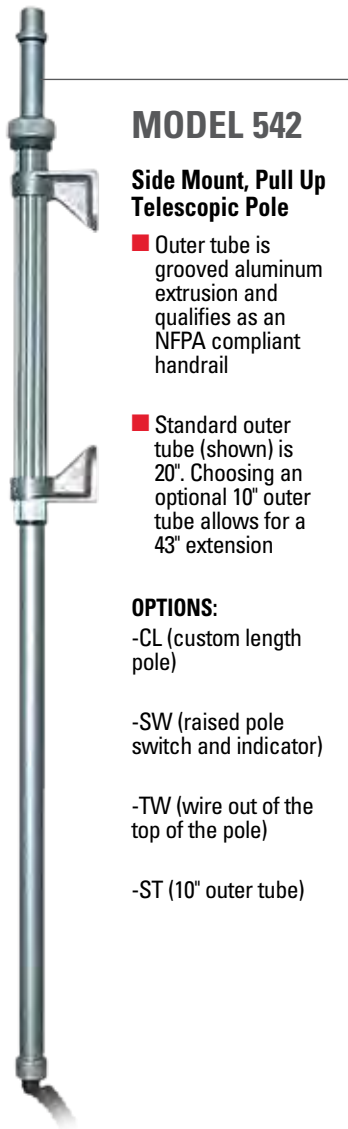

MODEL 542

Side Mount, Pull Up Telescopic Pole

- Outer tube is grooved aluminum extrusion and qualifies as an NFPA compliant handrail
- Standard outer tube (shown) is 20". Choosing an optional 10" outer tube allows for a 43" extension

OPTIONS:

- CL (custom length pole)
- SW (raised pole switch and indicator)
- TW (wire out of the top of the pole)
- ST (10" outer tube)

All FRC pole brackets are adjustable along the pole.

SIDE MOUNT BRACKETS

Supplied as Pair



Side Mount Bracket Dimensions

All Dimensions in Inches

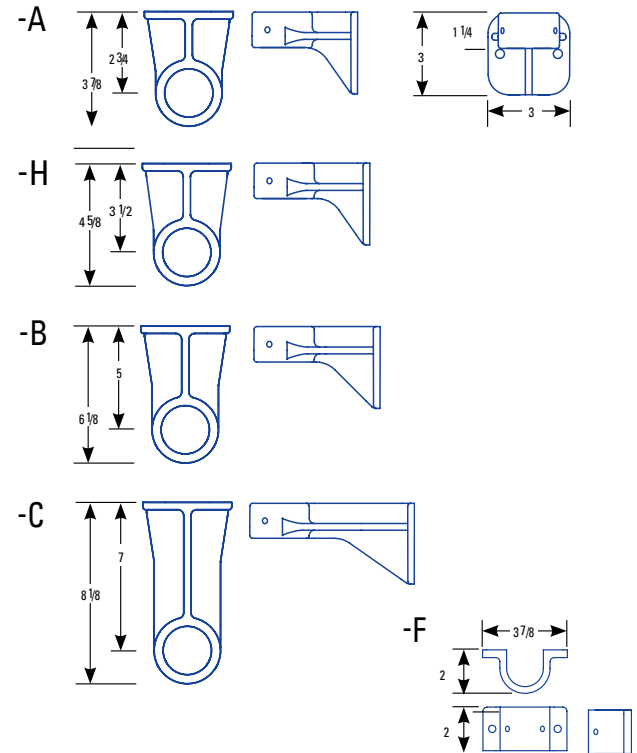

GROOVED GRAB HANDLE

- FRC's exclusive GRAB-HANDLE is a standard feature on all 530, 540 and 542 telescopic poles.
- It provides a secure grip when wearing heavy gloves.
- The grab handle qualifies as an NFPA compliant handrail.



OPTIONAL MOUNTS



- SR**
Optional Steady Rest
Steady Rest bracket provides added bottom support for "inside pole" when it is in the retracted (down) position. Bracket can be used with 512 and 530 push-up poles.



- F**
Optional Flush Mount
Flush mount brackets allow poles to securely mount flush to a surface. Total width is 3.875". Supplied as pair.

TWISTLOCK

TELESCOPIC POLES TECHNICAL SPECIFICATIONS

TWIST-LOCK TOP MOUNT POLES

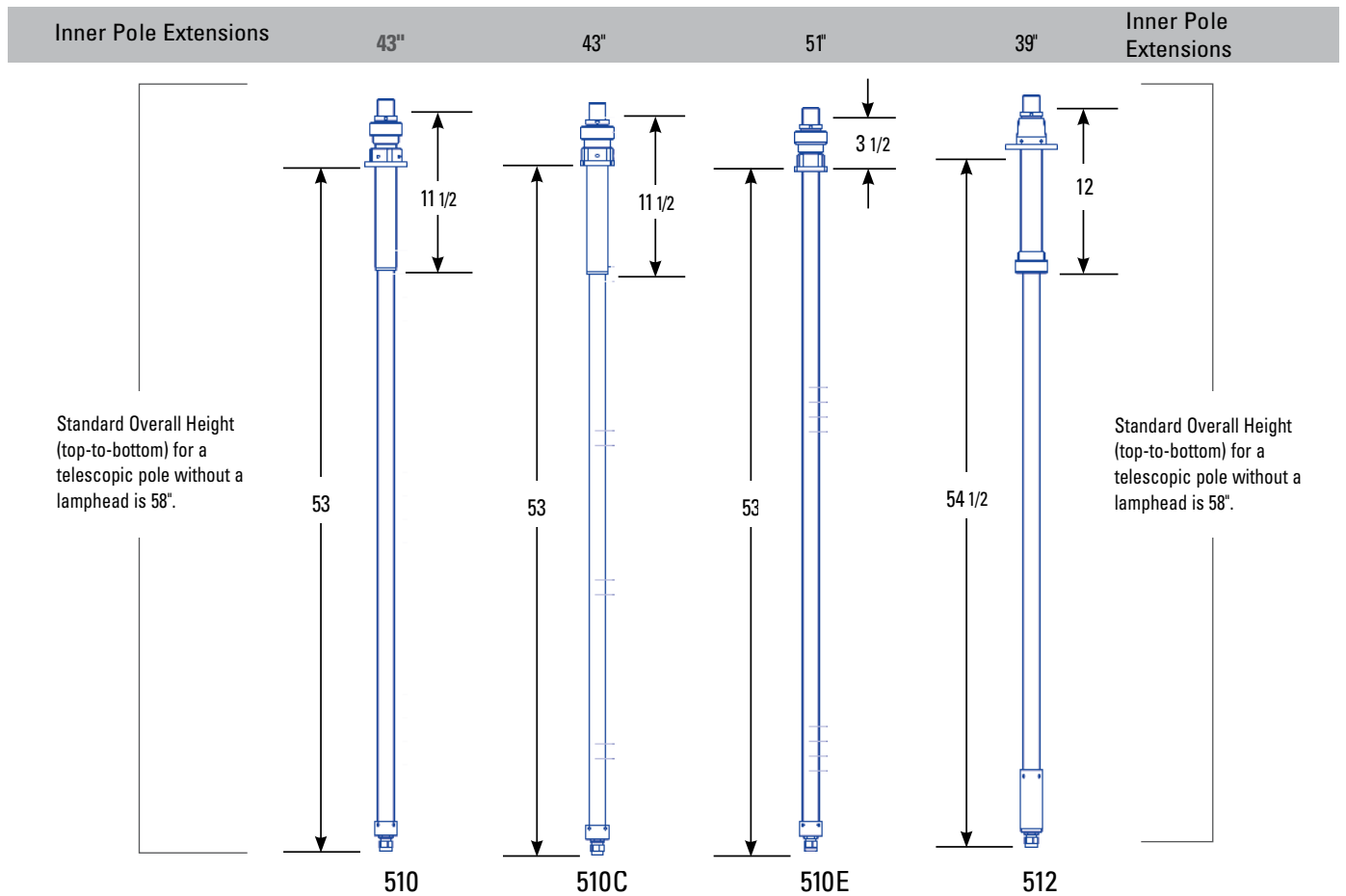

TWISTLOCK

TELESCOPIC POLES TECHNICAL SPECIFICATIONS

TWIST-LOCK SIDE MOUNT POLES

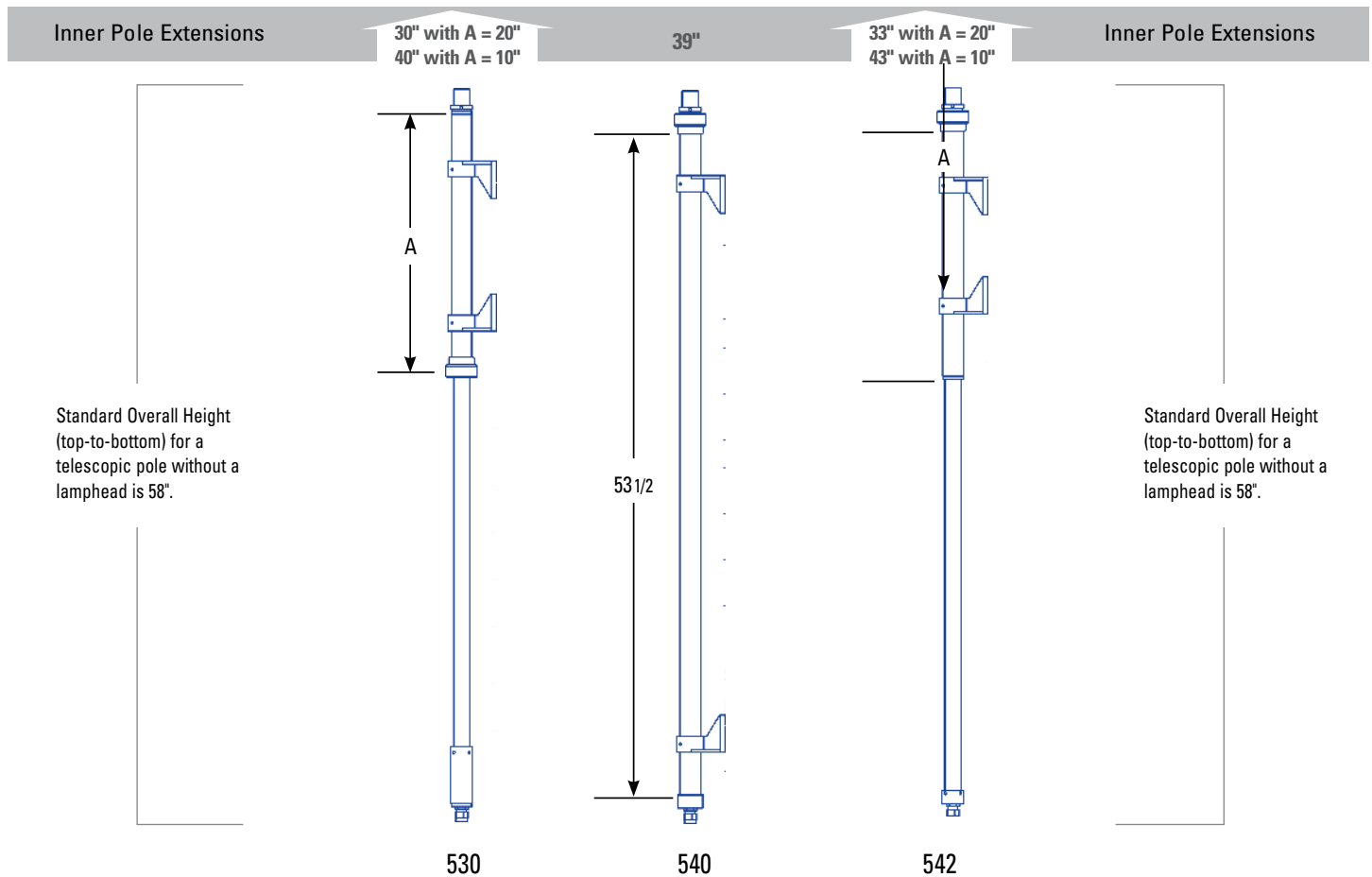



SPECTRA TRIPOD ULTRABRIGHT

THE ONLY 32,000 LUMEN AC POWERED LED LAMPHEAD AVAILABLE.

FRC Tripods are Available with the Following Lampheads:

RADIANT ECO: K15	SPECTRA MAX-S: B28, C28
RADIANT MAX: K32	SPECTRA MS: T14, U14
SPECTRA: J20, K20	FOCUS: S30, S50, S75, M10, M12, M15
SPECTRA MAX: J28, K28	

OPTIONAL QUICK RELEASE TRIPOD BRACKETS

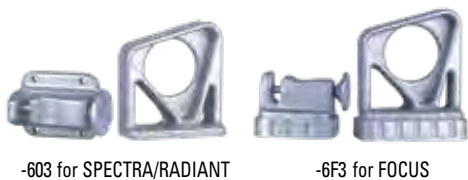

- The 603 bracket sets consist of a small triangular bracket for the feet and a QUICK RELEASE spring loaded dead-bolt lock to hold the tripod at its midpoint
- The brackets can be used on the exterior of a vehicle or in a compartment
- The 6F3 has spacers needed for FOCUS lampheads



-603D for SPECTRA/RADIANT
-6F3D for FOCUS

- Similar to the 603, the dual bracket consists of a small triangular bracket for the feet and a DUAL QUICK RELEASE spring loaded dead-bolt lock to hold the tripod at its midpoint. The lock can be released from either side.

Tripod Bracket Dimensions

All Dimensions In Inches* FOCUS Lampheads Require the included 7/8" spacer.

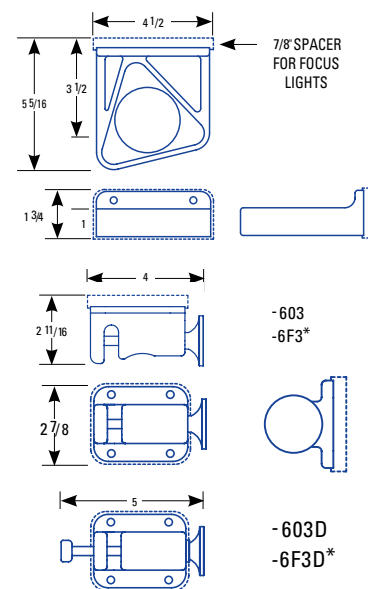

TWISTLOCK

TELESCOPIC TRIPODS

TWISTLOCK TELESCOPIC TRIPODS

The Industry's Finest Tripods with the Best Features:

- **TwistLock** – FRC's unique locking ring operates from either direction. It is simply the best way to deploy a light with the gloved hand!
- **Air Cushioned pole release** – This innovation allows the pole to lower slowly, when released, on a cushion of air. This helps to prevent pinched fingers and damage to the bulb.
- **Ease of set-up** – FRC tripods are designed to deploy all three legs at the same time, allowing the unit to be set up quickly and easily at an incident.
- **Lightweight anodized aluminum poles** – The standard tripod weighs just 16 pounds!
- **Extends up to 12 feet!** – Fire Research tripods are designed to permit "overextension" of its legs so the tripod's lamphead can reach this incredible height.
- **Cammed knobs** – The pole tightening knob will not unscrew or come off due to vibration.
- **Anti-chatter legs** – Rubber covers at the bottom of the legs ensure a quiet ride.
- **Small footprint** – When closed the unit sets into an incredibly small lower bracket allowing ease of mounting just about anywhere!
- **Truck mountable** – All tripods are truck mountable, allowing them to be used as telescoping lights on the vehicle and off!
- **Wire Guard** – As shown is standard.

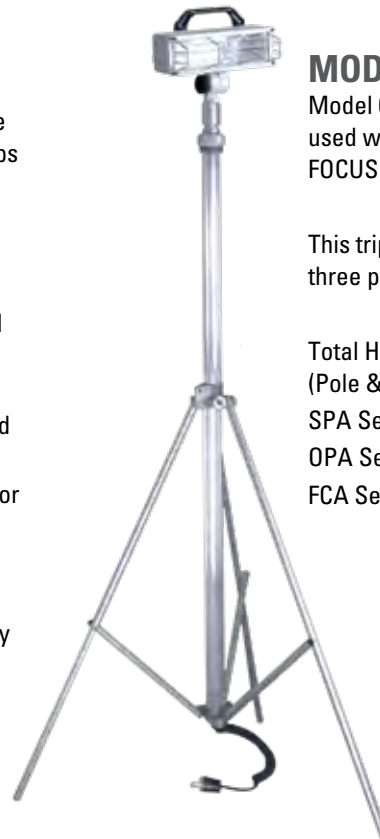

MODEL 600

Model 600 is a standard tripod that can be used with either RADIANT, SPECTRA, or FOCUS lampheads.

This tripod is supplied with a NEMA L5-15 three prong TwistLock plug.

Total Height of Model 600 with Lamphead (Pole & Legs Retracted)
 SPA Series = 72" high
 OPA Series = 69" high
 FCA Series = 69" high

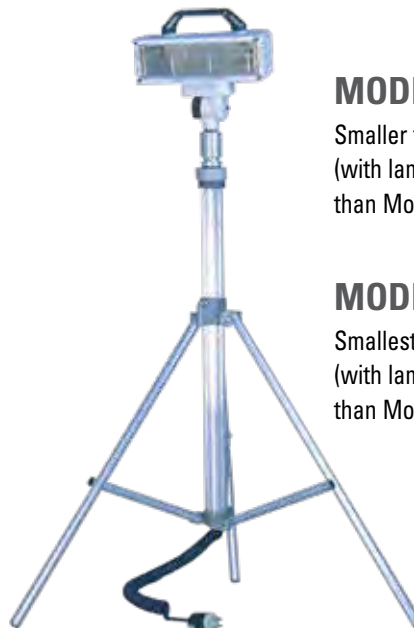

MODEL 656

Smaller tripod, overall length (with lamphead) is 14" smaller than Model 600.

MODEL 642

Smallest tripod, overall length (with lamphead) is 27" smaller than Model 600.

	600	656	642
A	59	45 1/4	31 3/4
B	99	73 1/2	48 3/8
C	75 1/8	61 1/2	44 3/4
D	115 1/8	89 3/4	61 3/8
E	43 1/2	43 1/2	30 1/2

NOTE: The tripod comes with the power cord exiting from the bottom of the pole. For the power cord to exit from the top of the pole add the -TW option. When the -TW option is installed add 1" to the lamphead dimension and on a standard pole add 8" to dimensions B and D.

Tripod shown from side view with quick release truck mount bracket set

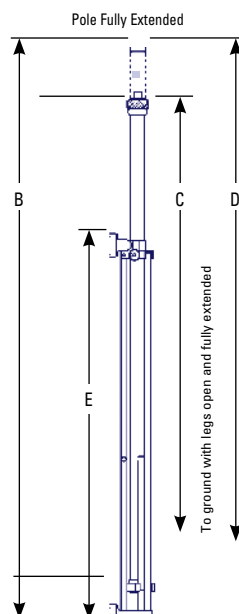



SPECTRA with fixed top mount shown

300 UNDER AERIAL

The 300 adjustable aerial mounting brackets allow the EVOLUTION lamphead to be mounted under an aerial bucket or platform. Aim the light forward or directly downward. Commonly set at 30° downward as shown.



REQUIRED CLEARANCE

- Aimed Directly Forward - 4"
- Aimed At 30° Downward - 6.5"
- Aimed At 45° Downward - 6.75"
- Aimed Straight Down - 7.5"

KR-SB-600 FIXED TOP MOUNT

The KR-SB-600 fixed top mount includes a two-piece locking collar and is designed to allow for easy 360 degree rotation.

- Also available with clamping lever (KR-SB-600-L)





EVOLUTION II with fixed top mount

570 FIXED TOP MOUNT

More than a simple top mounted base, the 570 allows for a full 450° of rotation. This means that light coverage can be a full circle, plus another quarter turn which ensures no blind spots. The 570 base has a built-in stop to prevent the internal wiring from binding.

A built-in friction mechanism ensures the light will not rotate when the vehicle is in motion.



EVOLUTION II with fixed side mount



SPECTRA with fixed side mount

580 FIXED SIDE MOUNT

The 580 side mounted, fixed pedestal light allows the lamphead to rotate 450° and has a self adjusting friction brake to prevent arbitrary rotation.

The pedestal has around mounting base attached to a side mount bracket.

SPECTRA lampheads use a 2.75" bracket.

EVOLUTION II lamphead uses a 3.5" bracket.

LIGHT OPTIONS

SPECTRA AND EVOLUTION II



Guide Rail

Guide Collar

Steady Rest Bracket
Available with 3.5" or 5" brackets.

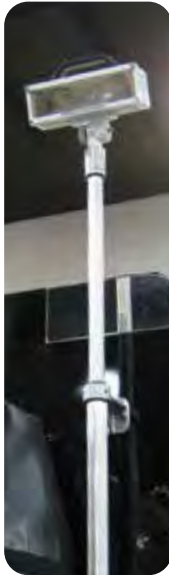

-NS

PATENTED NO-SCRATCH OPTION

Ordered with the 530 pole by adding the suffix -NS to the part number.

-NS Option includes:

- (2) Rubber Bumpers (FOCUS & EVOLUTION II only)
- (1) Guide Collar & Guide Rail
- (1) Steady Rest Bracket

FC-NS31K

The Rubber Bumpers can be ordered separately and installed on all standard FOCUS lampheads.

FC-NS31K Kit includes:

- (2) Rubber Bumpers
- (2) 1/8" Rivets with Backing Plates

FC-NSK

The No-Scratch option can be retrofitted on existing 530 poles.

FC-NSK Kit includes:

- (1) FC-NS31K Kit
- (1) Guide Collar & Guide Rail Assembly

Note: It is recommended that the Steady-Rest bracket be installed with the No-Scratch retrofit kit. Order FC-NSK-SR

FOCUS

NO SCRATCH GUIDE & RUBBER BUMPERS PREVENTS SCRATCHING & DENTING

The No-Scratch option combines a guide collar and guide rail assembly, a steady-rest bracket, and two rubber bumpers on the lamphead (FOCUS & EVOLUTION II only) to prevent scratching and denting of apparatus body surfaces. The complete No-Scratch option is available on 530 side mount, bottom raise, telescopic pole.

When the pole is raised the guide collar disengages from the guide rail and the lamphead is free to rotate 360°. As the pole is lowered the guide collar engages the guide rail. The guide collar and rail prevents the pole from being lowered if the lamphead is not correctly aligned.

RUBBER BUMPERS

Rubber Bumpers are available as an option on most FOCUS and EVOLUTION II lampheads

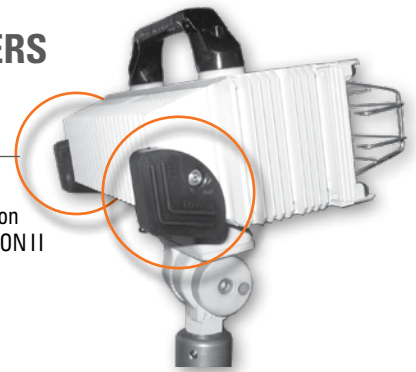

RAISED POLE INDICATOR & SWITCH

In order to alert the vehicle operator that an extendable pole is raised, FRC offers a switch and indicator option for all permanently mounted telescopic poles. The parts associated with this option will differ depending upon the type of pole in question.

Note: To retrofit this option the type of pole being used needs to be specified when ordering.



If retrofitting this option on a 530 push-up pole the steady rest lower bracket is required.



WIRE GUARD

When retrofitting a wire guard on a FOCUS lamphead not originally fitted with one order the FC150-S or FC150-M kit. Wire Guards are not available on Model 200, 230, and 250 recessed mounts.

ON/OFF LAMPHEAD SWITCH

On SPECTRA, EVOLUTION II and FOCUS lampheads a switchbox is provided underneath the lamphead.

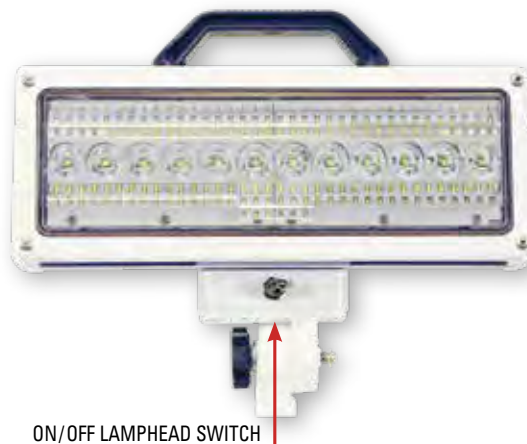

ON/OFF LAMPHEAD SWITCH

CUSTOM LENGTH POLE

FRC telescopic poles can be shipped pre-cut to a custom length. Total length will include pole and lamphead.

(Some restrictions apply)



WIRE EXITS FROM TOP OF POLE NON-CONCEALED WIRE

For most permanently mounted lampheads the power cord exits through the bottom of a pole assembly. Specifying this option will bring the power cord out of the top of the pole or lamphead.

AC PLUGS

- P1 Nema 5-15 Straight (household type) plug
- P3 Nema L5-15 3-Prong twist lock plug



-P1



-P3

ORDERING INSTRUCTIONS

RADIANT, SPECTRA, EVOLUTION II, FOCUS, SO BRITE

4 SIMPLE STEPS Follow the four steps shown below to get your final product number. Need help? Call us.

1
Indicate the
LIGHT PREFIX

RDA
for RADIANT

SPA
for SPECTRA

FCA
for EVOLUTION II

FCA
for FOCUS

SRA
for SoBRITE



SPA

+

2
Choose a
POLE STYLE OR MOUNT

Poles

- 510
- 510C
- 510E
- 512
- 530
- 540
- 542

Tripods

- 600
- 642
- 656

Fixed Mounts

- 100
- 110
- 200
- 210
- 250
- 260
- 300
- 300U
- 570
- 580
- KR700
- 900
- 950

Brow Mounts

- 800
- 830
- 850
- .
- .
- .



530

+

3
Choose a
LAMPHEAD

- Q15
- Q20
- Q28
- Q50
- Q70
- K15
- K20
- K28
- J15
- J20
- J28
- A28
- B28
- C28
- R14
- T14
- U14
- 07A
- 07B
- 07C
- V11
- V15
- V20
- S30
- S50
- S75
- M10
- M12
- M15
- D15
- D30

- K20

+

4
Choose
OPTIONS

- F flush mount bracket
- SR steady rest bracket
- CL custom length pole
- G wire guard
- NS no-scratch guide kit
- RB rubber bumpers
- ST 10" outer tube

Electrical

- ON on/off switch
- SW raised pole indicator & switch
- TW wire exits top of pole

Brackets

- A
- B
- C
- H
- 603
- 6F3



- ON

= SPA530-K20-ON



LAMPHEAD DIMENSIONS

Radiant ECO- RDB100

Model	W	D	H
Q15,K15	11.25	2.9	7

Radiant MAX-RDA100

Model	W	D	H
Q32,K32	13.75	3.75	7.5

Radiant Lux-RDC260

Model	W	D	H
K32	16.25	2.1875	6.25

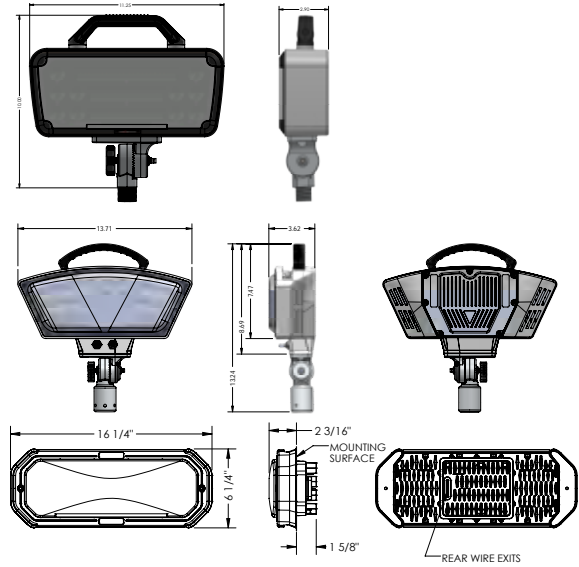

SPA100, SPA500, SPA600, SPA.700

Model	W	D	H	H ₂
Q15, Q20, Q28, K20, K28,				
J20, J28, A28, B28, C28	14	3 3/4	11	5 3/8
R14, T14, U14	8 3/4	3 1/4	11	6 1/2

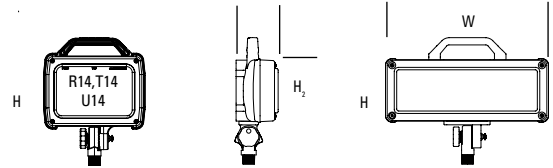

SPA260

Model	W	D	H	W ₂	D ₂	H ₂
Q15, Q20	14 1/2	1 3/4	5 7/8	-	-	-
K15, K20, J15, J20	14 1/2	1 3/4	6	6 3/8	1 13/16	4 11/16

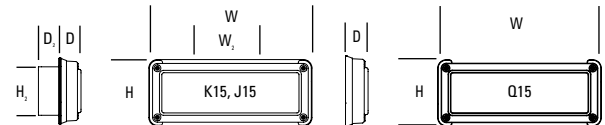

AC surface mount requires a cut-out

SPA800

Model	W	D	H	D ₂ Max
Q15, Q20, Q28, K20, K28,	14	*	5 7/8	*
J20, J28, A28, B28, C28				
R14, T14, U14	8 3/4	*	6 1/2	*

* Measurement varies depending upon cab model

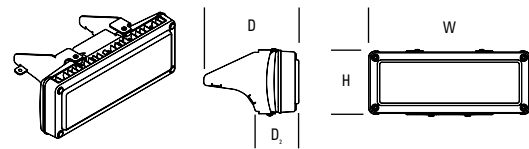

SPA850

Model	W	D	H	D ₂
Q15, Q20, Q28, K20, K28,	14	7 5/8	5 3/4	3 5/8
J20, J28, A28, B28, C28				
R14, T14, U14	8 3/4	7 1/2	6 3/4	3 1/4

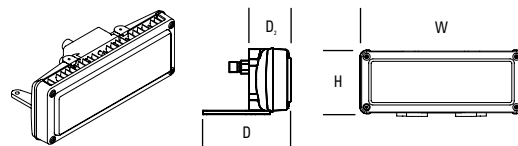

SPA830

Model	W	D	H
Q15, Q20, Q28, K20, K28,	14	4 3/4	6
J20, J28, A28, B28, C28			
R14, T14, U14	8 3/4	4 3/16	6 1/2

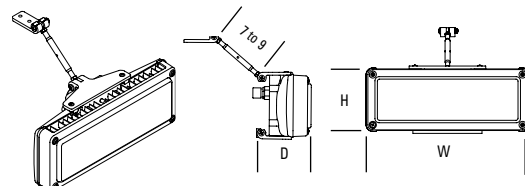

LAMPHEAD DIMENSIONS

FCA100, FCA500, FCA600, FCA700

Model	W	D	H	H ₂
V11	7 5/8	5 3/16	9	3 5/16
V20	11 1/2	5 3/16	9	3 5/16
D15, H30, S30, S50, S75, S72	10	5	9	3 5/16
D30	11 1/2	5 3/16	9	3 5/16
M10, M12, M15	15	5	9	3 5/16

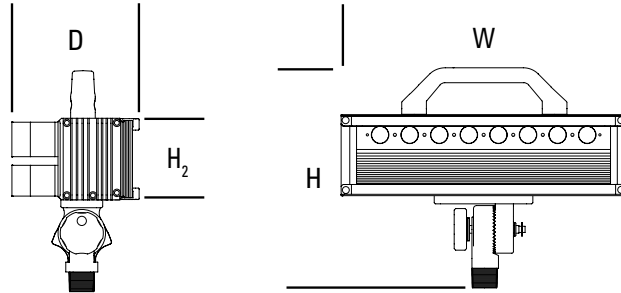

FCA200, FCA210

Model	W	D	H	W ₂	D ₂	H ₂
FCA200						
D15, H30, S30, S50	11	2	5 5/8	9 3/4	1 15/16	4 1/4
D30, M10, M12	17 1/2	2	5 5/8	15 7/8	1 15/16	4 1/4
FCA210						
V15	13 7/8	2	5 7/8	12 1/2	1 15/16	4 1/2
S75, S72	13 7/8	2	5 7/8	12 1/2	1 15/16	4 1/2

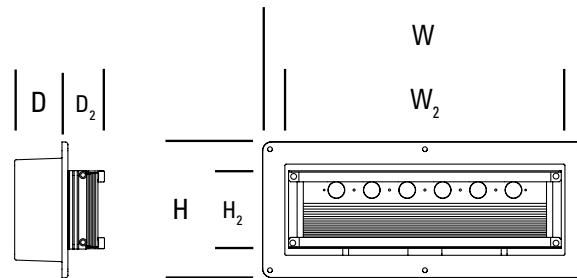

FCA300

Model	W	D	H	D ₂
V20	11 1/2	6 1/2	3 7/8	5
D15, D30, H30, S30, S50, S75, S72	11 1/2	6 1/2	3 7/8	5
M10, M12, M15	15	6 1/2	3 7/8	5

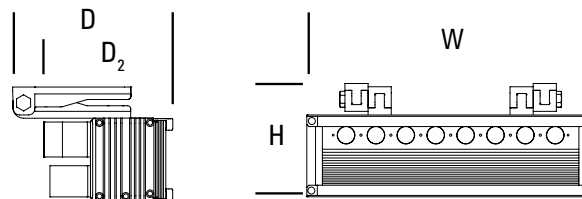

LAMPHEAD DIMENSIONS

FCA800

Model	W	D	H	D ₂ Max
V11	7 5/8	9 5/16	4 3/4	5 5/16
V20	11 1/2	9 5/16	4 3/4	5 5/16
D15, D30, H30, S30, S50, S75, S72	11 1/2	9 5/16	4 3/4	5 5/16
M10, M12, M15	15	9 5/16	4 3/4	5 5/16

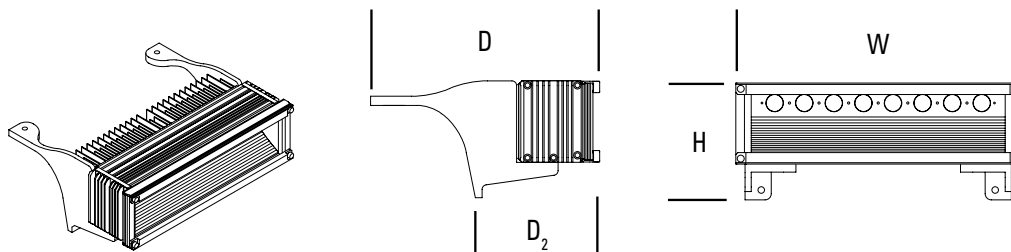

FCA850

Model	W	D	H	D ₂
V11	8 1/8	7 1/2	3 5/8	5 3/16
V20	12	7 1/2	3 5/8	5 3/16
D15, H30, S30, S50, S75, S72	12	7 1/2	3 5/8	5
D30	12	7 1/2	3 5/8	5 3/16
M10 M12 M15	15 1/2	7 1/2	3 5/8	5 3/16

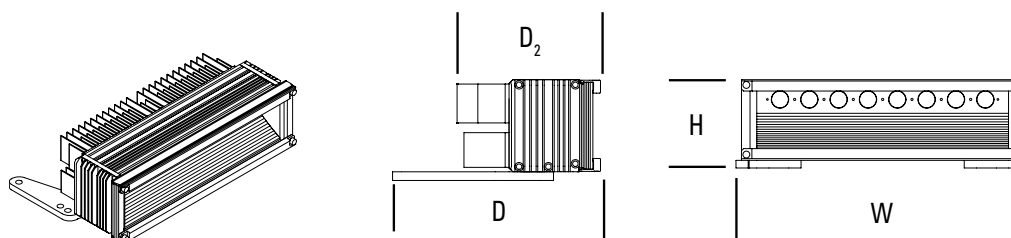

FCA830

Model	W	D	H
V20	11 1/2	5 3/16	4 5/8
D15, D30, H30, S50, S72	11 1/2	5 3/16	4 5/8
M10, M12, M15	15	5 3/16	4 5/8

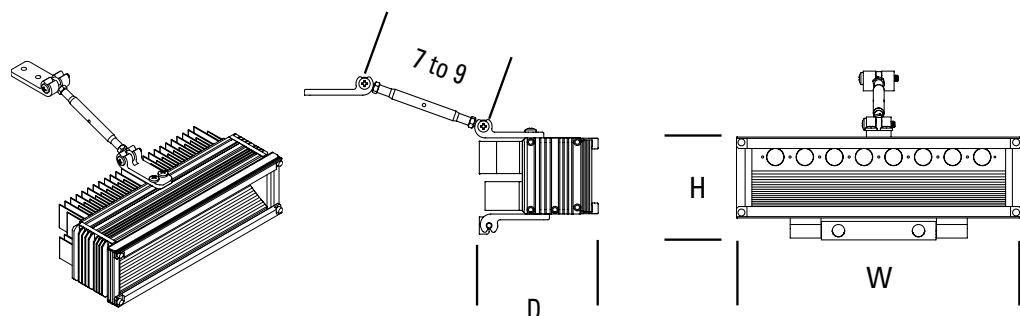



MODEL: LED330



MODEL: LED310



MODEL: LED300



MODEL: LED350

WORKPRO™ WORK AREA, ULTRA BRIGHT LED LIGHT SERIES

**RUGGED COMPACT,
VERSATILE AND POWERFUL**



- Delivers outstanding light output
- Built tough for long life in the harshest environments
- Robust cast aluminum housings with polycarbonate lens

- Protected against shock, RFI/EMI interference, voltage surges, UV and reverse polarity
- IP67 or IP68 compliant against dust & water ingress
- Extremely affordable
- Many model sizes/available in black or white

PART NO. DESCRIPTION W/MOUNTING BRACKET

LED300 - A01	LED, SPOT, 12/24 VDC, 20W, Square 3"x 3 3/32", 1800 lumens
LED300 - B01	LED, FLOOD, 12/24 VDC, 20W, Square 3"x 3 3/32", 1800 lumens
LED310 - A03	LED, SPOT, 12/24 VDC, 35W, Round 5 5/8", 3500 lumens
LED310 - B03	LED, FLOOD, 12/24 VDC, 35W, Round 5 5/8", 3500 lumens
LED320 - A03	LED, SPOT, 12/24 VDC, 35W, Square 5 1/2", 3500 lumens
LED320 - B03	LED, FLOOD, 12/24 VDC, 35W, Square 5 1/2", 3500 lumens

PART NO. DESCRIPTION W/MOUNTING BRACKET

LED330 - A01	LED, SPOT, 12/24 VDC, 26W, Square 5 1/2", 1800 lumens
LED330 - B01	LED, FLOOD, 12/24 VDC, 35W, Square 5 1/2", 1800 lumens
LED340 - A07	LED, SPOT, 12/24 VDC, 78W, Round 7 1/2", 7200 lumens
LED340 - B07	LED, FLOOD, 12/24 VDC, 78W, Round 7 1/2", 7200 lumens
LED350 - A07	LED, RECESSED, 12/24 VDC, 18W, 7 11/16"x 2 7/16", 1620 lumens



ALL MODELS AVAILABLE IN SPOT OR FLOOD

WORKPRO LED-3xx SERIES

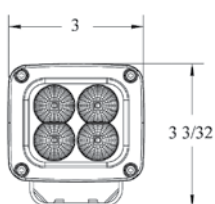

MODEL: LED300

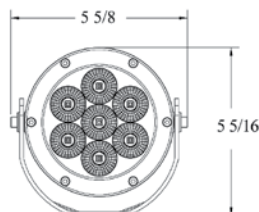

MODEL: LED310

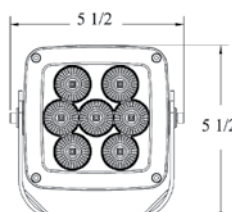

MODEL: LED320/330

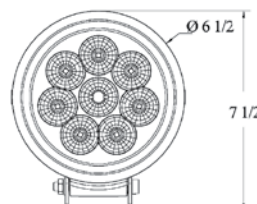

MODEL: LED340

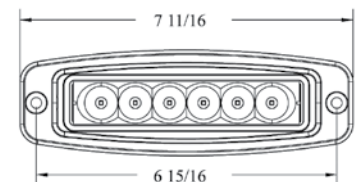

MODEL: LED350



Old Halogen/HID New LED

BRIGHTER SCENES & SAFER FIRE GROUNDS

SAFER, WHITER & BRIGHTER

LEDs Produce More Light

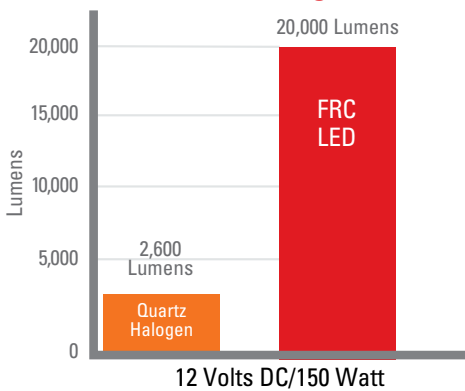

A quartz halogen bulb utilizes 8% of the energy supplied to produce light. By comparison, LEDs use 40% of the supplied energy to produce light.

LEDs Are More Efficient

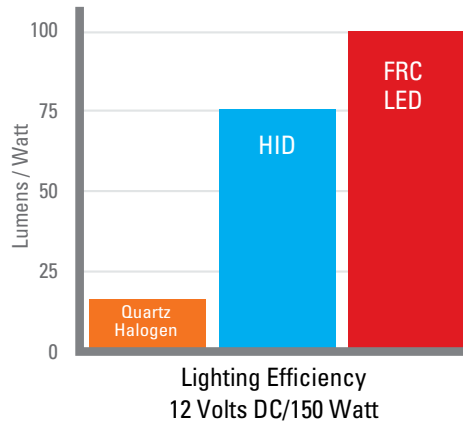

Different types of light sources that use the same amount of power (watts) can have very different luminous efficacy (lumens/watt) and therefore different lighting efficiency.

LEDs Outlast Traditional Bulbs

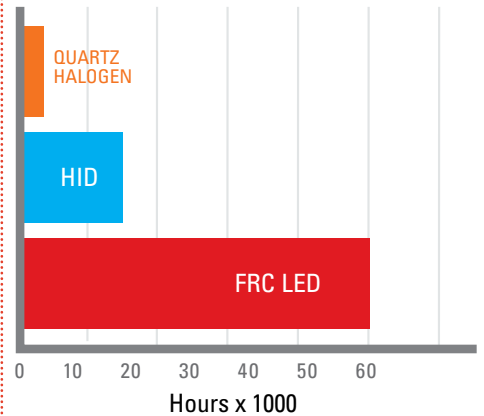

- The typical operational life of an LED is 50,000 hours compared to the average life of an incandescent bulb, which is approximately 2,000 hours.
- LEDs can operate well past the lifetime of the average apparatus.
- Because of their inherent solid state design without filaments, LEDs are much more rugged than incandescent bulbs and can better withstand shock and vibrations.

HALOGEN AND HID TO LED RETROFIT

UPGRADE TO LED LIGHTING

FOCUS[®]

SPECTRA



OPTIMUM

EVOLUTION II



**OPTIMUM
HID**

SPECTRA MS



COLLINS

SOBRITE



**SEE MORE.
DO MORE.
SAVE MORE.**

INCREASE SAFETY, SIMPLE ORDER AND INSTALL.

- Easy order
- Drop-in replacement
- Safer scenes
- Simple installation
- Use existing wiring
- Less power
- No maintenance

LED LIGHT UPGRADE

UPGRADE TO SPECTRA OR SOBRITE LED LIGHTING NOW FOR SPECIAL PROMOTION PRICING!

Replace your Optimum, Focus and Collins Halogen and HID lighting with superior LED technology and improve your scene lighting. Contact your dealer with your current FRC model number to be replaced or visit upgradedyourlights.com to learn more. It's that quick and easy.

**CONTACT YOUR SALES
REPRESENTATIVE TODAY**



Contact Us
Complete a Contact Form

**WILL-BURT NORTH AMERICA
WORLD HEADQUARTERS**

401 Collins Boulevard, Orrville, OH 44667 USA
Telephone: +1 330 682 7015
Mast Customer Service: +1 330 684 4000
Fax: +1 330 684 1190
Email: info@willburt.com

**WILL-BURT
UNITED KINGDOM**

Unit 5b, Station Approach, Four Marks,
Alton Hampshire, GU34 5HN, United Kingdom
Telephone: +44 [0] 1403 265532
Fax: +44 [0] 1403 259072
Email: info@willburt.com

**WILL-BURT INTEGRATION
ALUMA TOWER | ITS**

7750 9th Street SW
Vero Beach, FL 32968 USA
Telephone: +1 772 567 3423 | +1 800 850 8535
Fax: +1 772 567 3432
Aluma Tower Email: info@alumatower.com
ITS Email: programs@itstowers.com

**WILL-BURT ASIA
SINGAPORE SALES OFFICE**

1 Fullerton Road, #02-01
One Fullerton, Singapore 049213
Telephone: +65 6832 5699
Fax: +65 6722 0664
Email: info@willburt.com

**WILL-BURT
GERMANY**

Fischergasse 25
D-91344 Waischenfeld, Germany
Telephone: +49 9202 180
Fax: +49 9202 1811
Email: info@willburt.com

**CLARK MASTS
A WILL-BURT COMPANY**

18-20 Ringwood Road, Binstead,
Isle of Wight, PO33 3PA, England
Telephone: +44 [0] 1983 563691/567090
Fax: +44 [0] 1983 566643/811157
E-mail: sales@clarkmasts.com

The Will-Burt Company, headquartered in Orrville, Ohio, USA, is the world's premier manufacturer of mobile telescoping masts, towers and pan and tilt positioners. We offer virtually every mobile payload elevation and integration solution for defense, government, first responders, cellular and mobile, broadcast, energy production and other markets. Will-Burt also offers contract manufacturing, metal fabrication, powder-coating, and rapid prototyping services. Will-Burt is an international company with offices and manufacturing in the USA, England, and Germany along with offices in Singapore. All Will-Burt Company manufacturing locations are backed by a certified ISO 9001:2015 Quality Management System. Incorporated in 1918, Will-Burt is 100% employee-owned and is classified as a small business.

Disclaimer: Dimensions and weights are for reference only and are subject to change. Please contact Will-Burt for current engineering specifications.

Copyright ©2022 Fire Research Corporation (FRC). All rights reserved. No part of this publication may be reproduced by any means without written permission from FRC. The information in this publication is believed to be accurate. However, FRC does not make any representation or warranty to that effect and does not assume responsibility for any consequences resulting from use of such information. Revisions or new editions of the publication may be issued (or not issued) in our discretion to incorporate such changes.



Will-Burt Terms and Conditions of Sale:
<https://www.willburt.com/support/service/will-burt-terms-conditions-of-sale/>

January, 2026
The Will-Burt Company
ISO 9001:2015
INNOVATION ELEVATED®